

**LEGO**

**STAR  
WARS**™

75115



**BUILDABLE  
FIGURES**



[LEGO.com/starwars](http://LEGO.com/starwars)

**Disney**

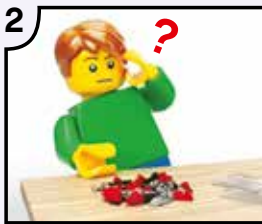

EN IMPORTANT: Never modify the elements or use other projectiles than provided with this toy.

DE WICHTIG: Die Elemente dürfen nicht verändert werden. Es dürfen ausschließlich die mit dem Spielzeug mitgelieferten Geschosse verwendet werden.

FR IMPORTANT : Ne jamais modifier les éléments ni utiliser d'autres projectiles que ceux fournis avec ce jouet.

IT IMPORTANTE: Non modificare gli elementi o utilizzare proiettili non forniti con questo prodotto.

NL BELANGRIJK: Verander niets aan de elementen en gebruik geen andere projectielen dan de bij het speelgoed geleverde.

ES IMPORTANTE: No modifique los elementos ni utilice otros proyectiles diferentes a los suministrados junto con este juguete.

DA VIGTIGT: Elementerne må ikke ændres, og der må ikke bruges andre projektiler end dem, der følger med legetøjet.

IS MIKLVÆGT: Aldrei skal breyta einingum vörunnar eða nota önnur skot en þau sem fylgja þessu leikfangi.

FI TÄRKEÄÄ: Älä koskaan tee osiin muutoksia tai käytä lelussa muita kuin sen sisältyviä ammuksia.

SV VIKTIGT: Modifiera aldrig delarna och använd aldrig andra projektiler än de som medföljer denna leksak.

NO VIKTIG: Elementene må ikke endres, og det må aldri brukes andre projektiler enn dem som følger med leketøyet.

PT IMPORTANTE: Nunca modifique os elementos nem utilize projecteis que não tenham sido fornecidos com este brinquedo.

EL ΣΗΜΑΝΤΙΚΟ: Ποτέ μην τροποποιείτε τα στοιχεία του παιχνιδιού και μην χρησιμοποιείτε άλλα βλήματα εκτός από αυτά που συνοδεύουν αυτό το παιχνίδι.

JA 重要: 部品を改造したり、本製品に付属の発射体以外のものを使用しないようにしてください。

ZH 重要提示: 切勿更改组件或使用并非由本玩具附带的弹丸。

KO 중요: 이물 부품을 수정하거나 이 완구와 함께 제공된 것이 아닌 발사체는 결코 사용하지 마십시오.

RU ВАЖНО: Запрещается вносить изменения в элементы или использовать другие снаряды, отличные от тех, которые поставляются с данной игрушкой.

PL WAŻNE: Nigdy nie modyfikować elementów ani nie używać innych pocisków niż dostarczonych z zabawką.

CZ UPOZORNĚNÍ: Nikdy neupravujte součástky a nepoužívejte jiné projektily než ty, které jsou dodávány s touto hračkou.

SK UPOZORNENIE: Nikdy neupravujte súčiastky a nepoužívajte iné projektily než tie, ktoré sú dodávané s touto hračkou.

HU FONTOS: Az elemeket nem szabad módosítani, és a játékhöz adott lövedékek helyett sem szabad mást használni.

UA УВАГА: Ніколи не модифікуйте елементи. Використовуйте тільки снаряди, що входять у комплект цієї іграшки.

HR VAŽNO: Nemojte nikad mijenjati elemente ili koristiti druge projektile osim onih koji bili priloženi uz ovu igračku prilikom kupnje.

SR VAŽNO: Nemojte da modifikujete elemente i ne koristite druge projektilne osim onih koji dolaze uz ovu igračku.

MK ВАЖНО: Никогаш не менувајте ги елементите и не користете други проектили од тие што ви се дадени со играчката.

SL POMEMBNO: Nikoli ne spreminjajte elementov in uporabljajte le izstrelke, ki so bili priloženi tej igrači.

RO IMPORTANT: Nu modificați niciodată elementele și nu utilizați alte proiectile decât cele furnizate cu această jucărie.

BG ВАЖНО: В никакъв случай не видоизменяйте елементите и не използвайте други снаряди освен предоставените с тази играчка.

LV SVARĪGI: Nekad nepārveidojiet rotāļietas elementus, vienmēr izmantojiet tikai tās komplektā iekļautās lodītes.

ET OLULINE: Mänguasja osi ei tohi teistega asendada, kasutada võib ainult kaasasolevat heitkeha.

LT SVARBU: Niekuomet nekeisikite elementų ir naudokite tik tuos šovinius, kurie yra pridėti prie šio žaislo.

TR ÖNEMLİ: Hiçbir zaman parçaları değiştirilmez veya bu oyuncakla verilenler dışında fırlatıcılar kullanmaz.

AR ملاحظة مهمة: جنب تعديل العناصر أو استخدام مكونات أخرى خلاف المرفقة مع هذه اللعبة

ID PENTING: Jangan pernah memodifikasi elemen atau menggunakan pelet lain selain yang disediakan bersama mainan ini.

MS PENTING: Jangan ubah suai elemen atau guna peluncur lain selain daripada yang disediakan untuk alat mainan ini.

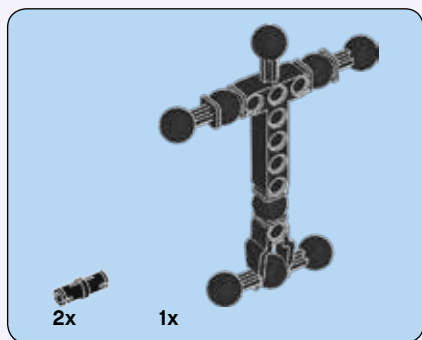

1

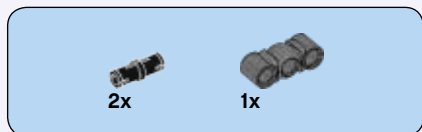
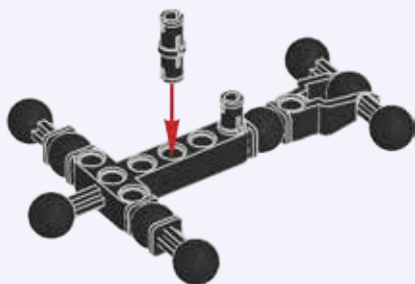

2

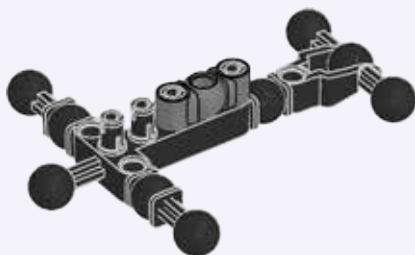

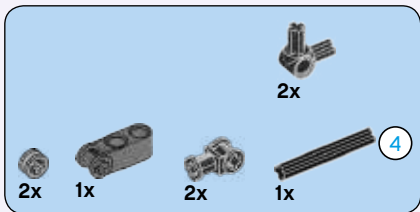

3

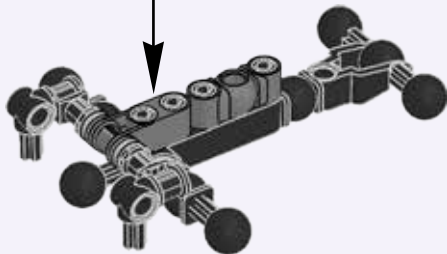
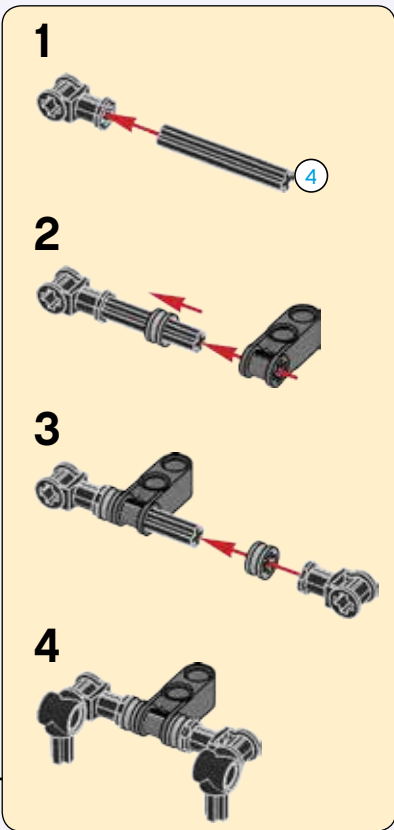

4

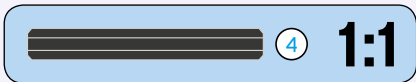

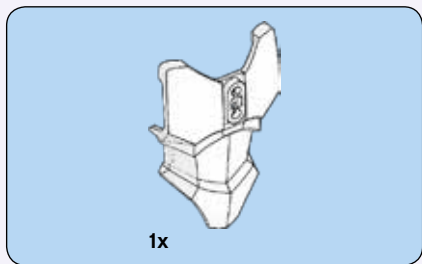

4

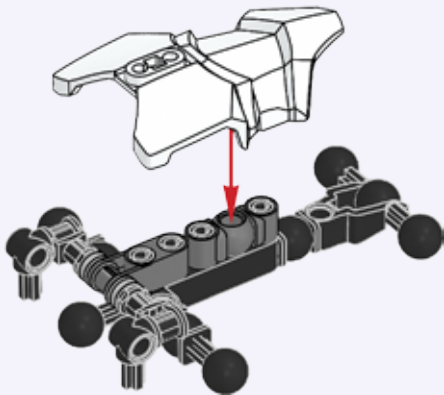

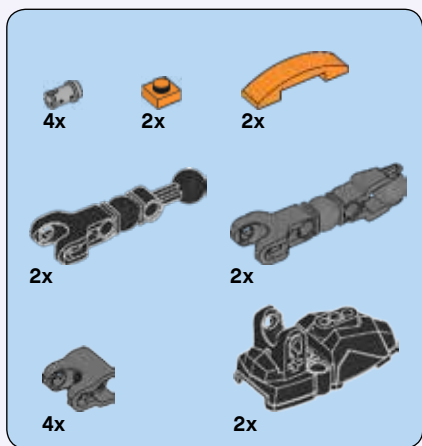

**5**

**1**

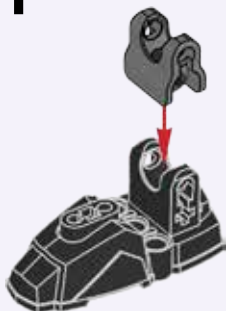

**2**

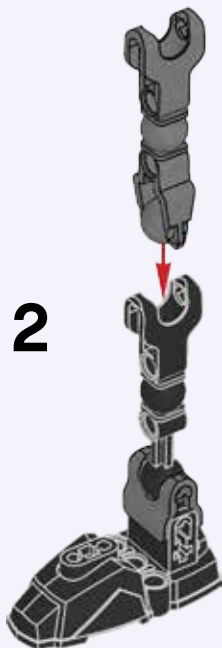

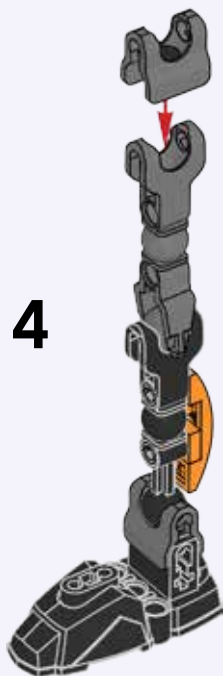
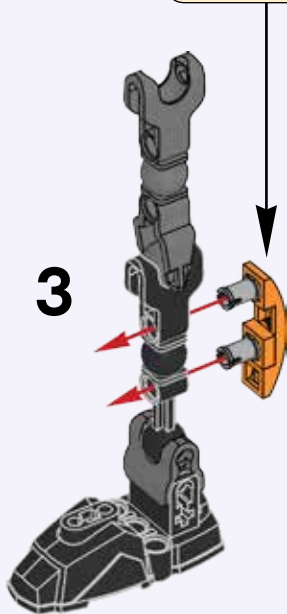
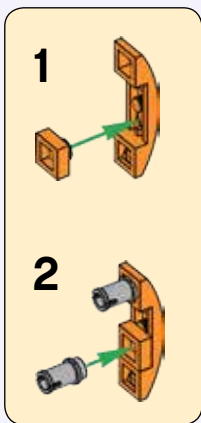

2x

6

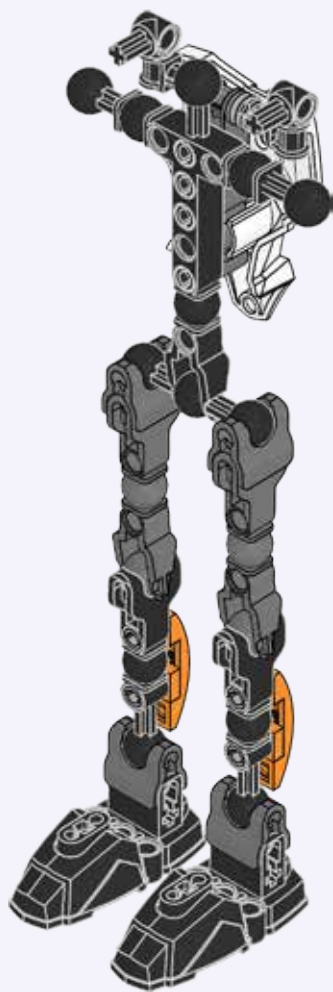

8





1x



1x

7

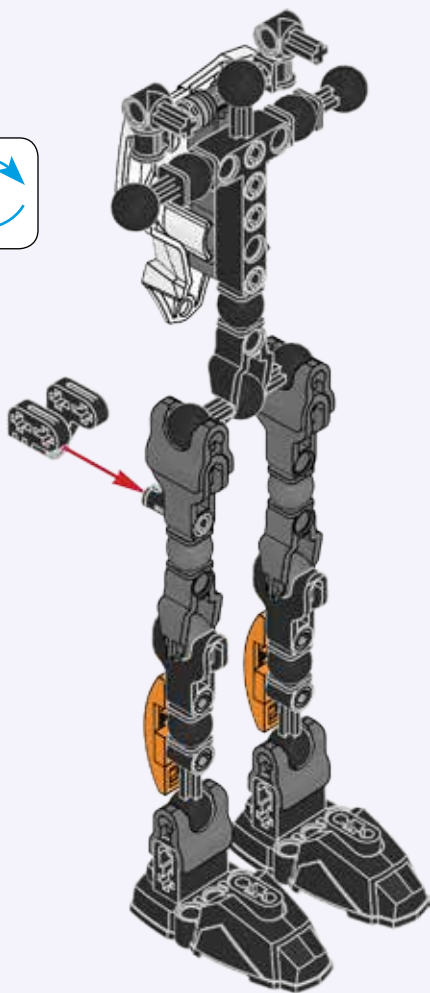
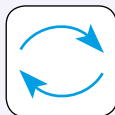

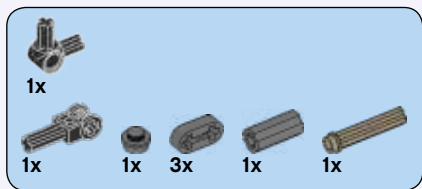

8

1

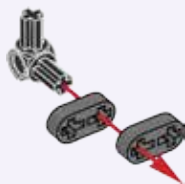

2

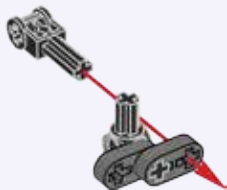

3

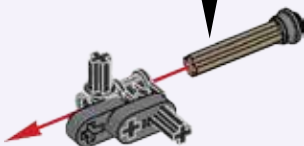
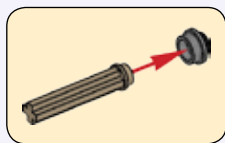

4

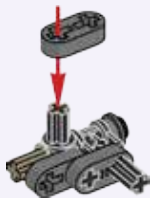

5

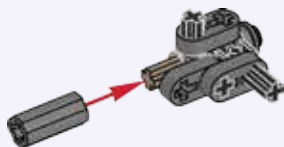

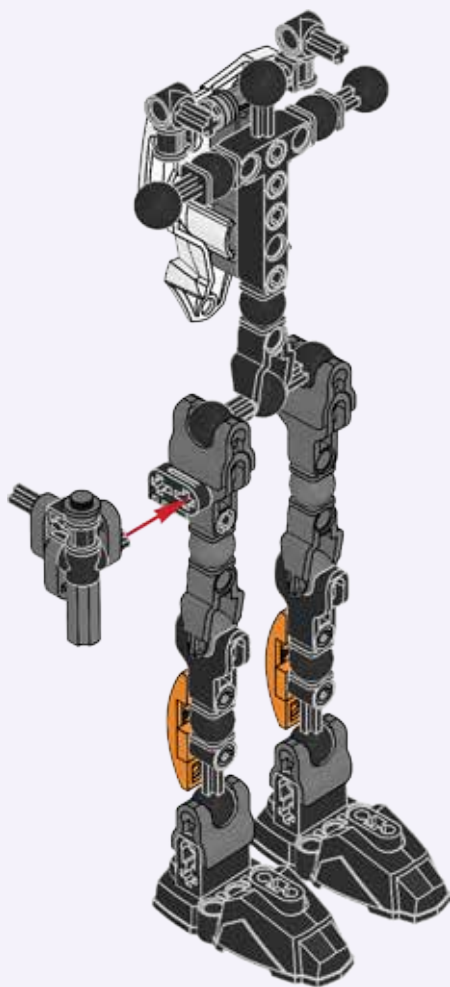

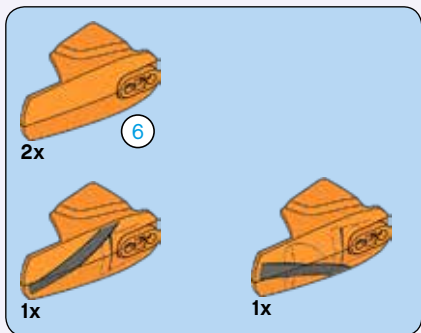

9

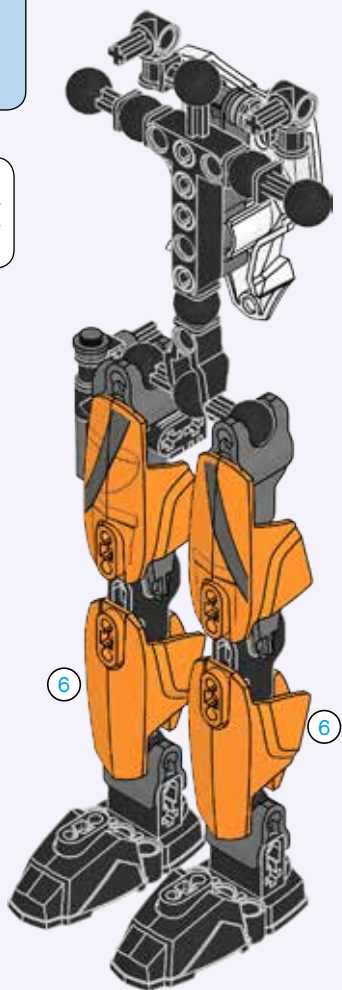
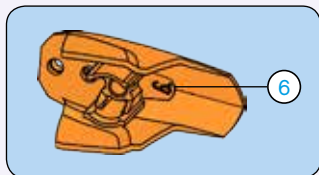
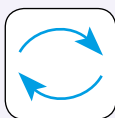

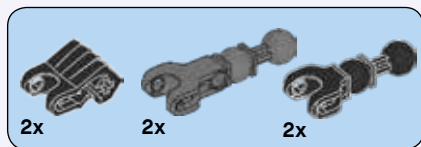

# 10

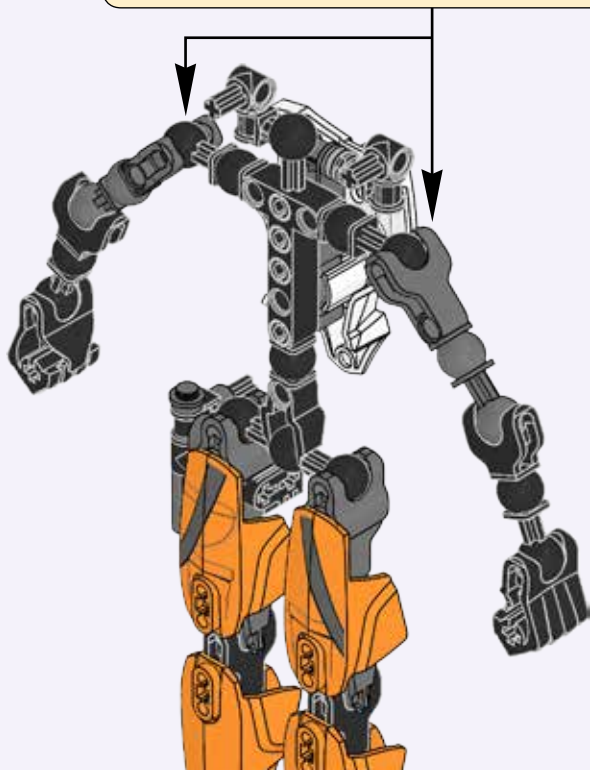
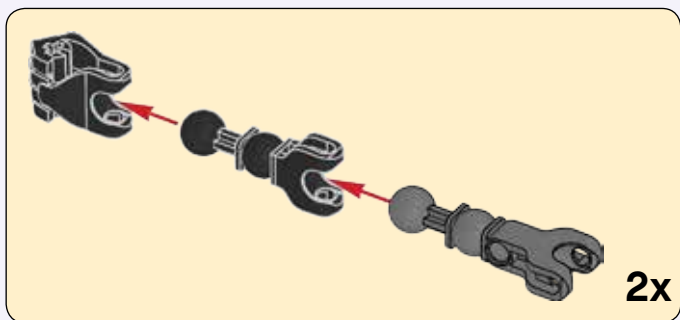

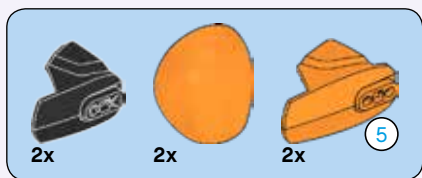

11

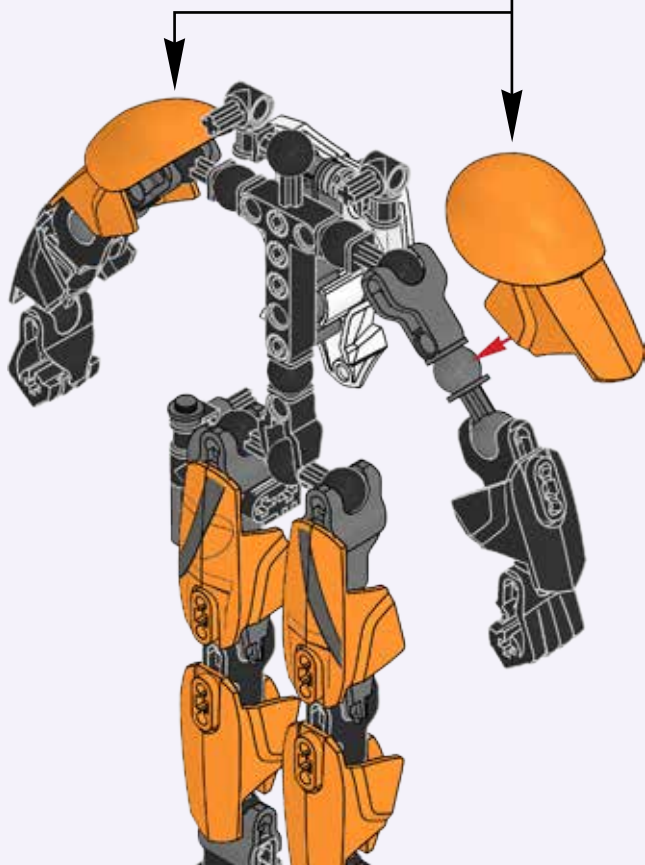
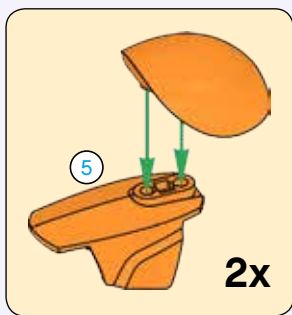
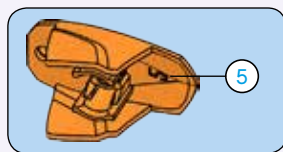

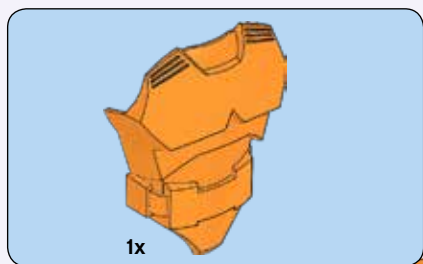

12

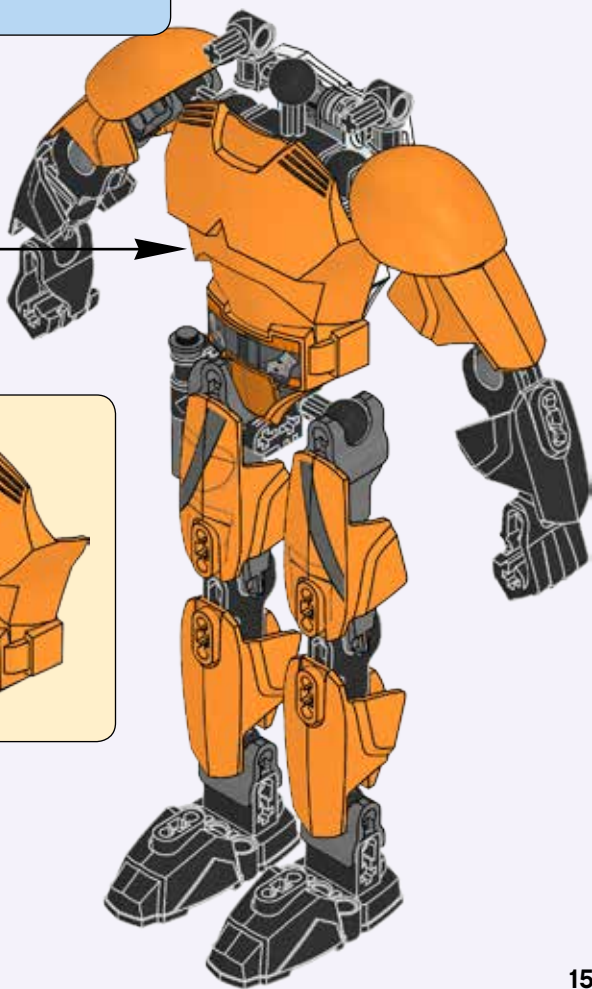
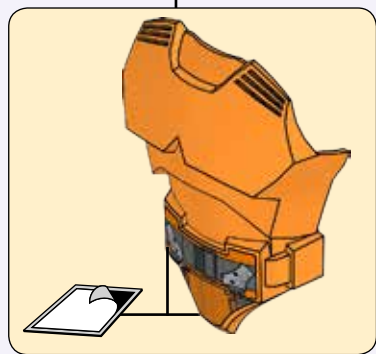



1x



1x

# 13



1x

# 14





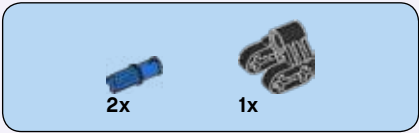

# 15

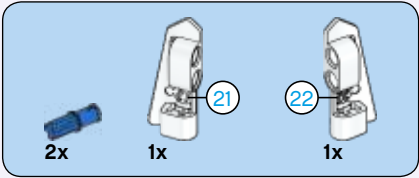
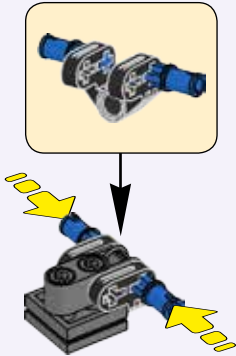

# 16

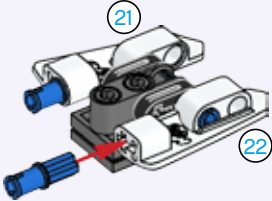



2x

# 17

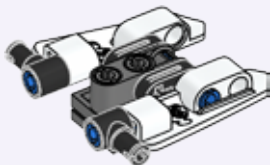

2x



2x



2x

# 18

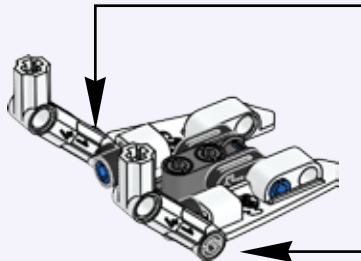
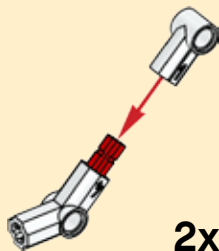

# 19

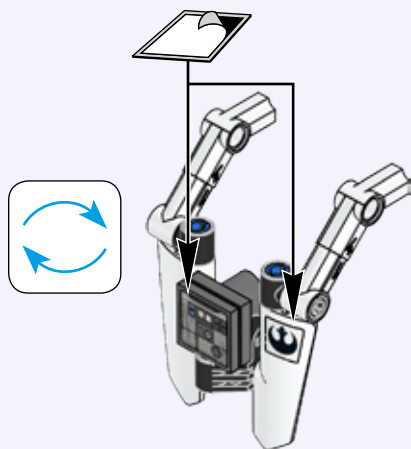

# 20

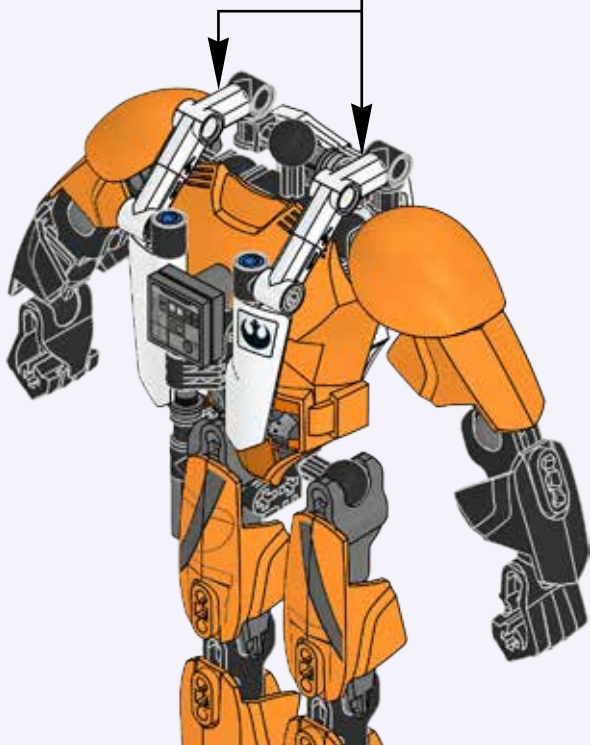



1x

# 21

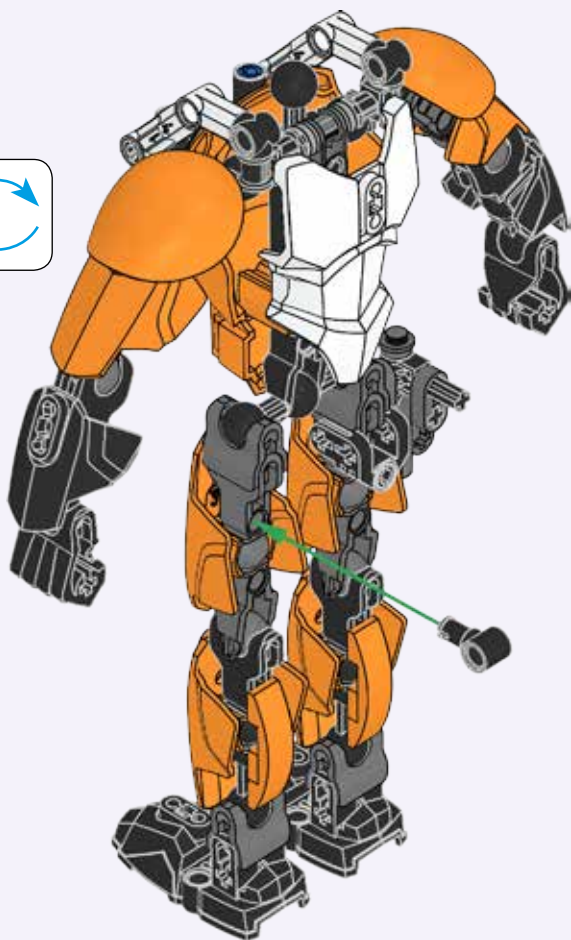
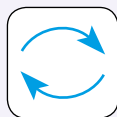

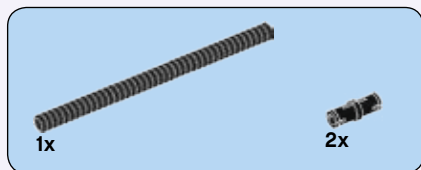

22

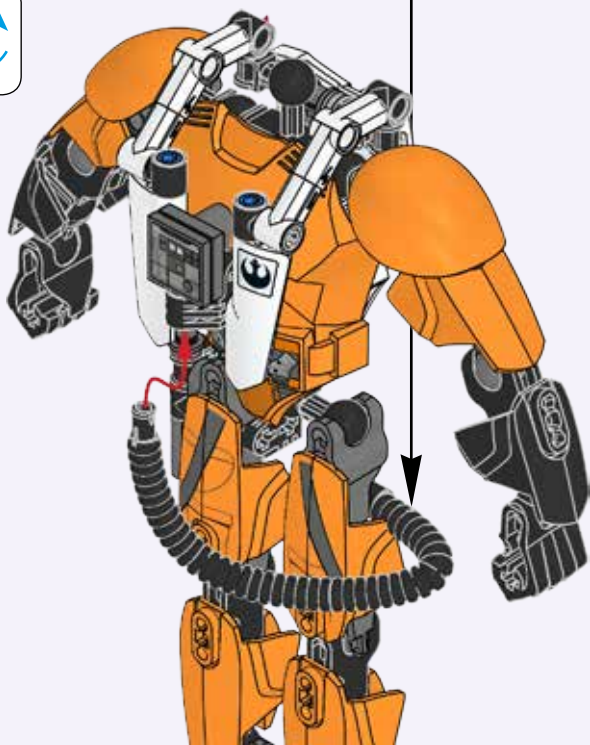
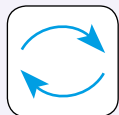
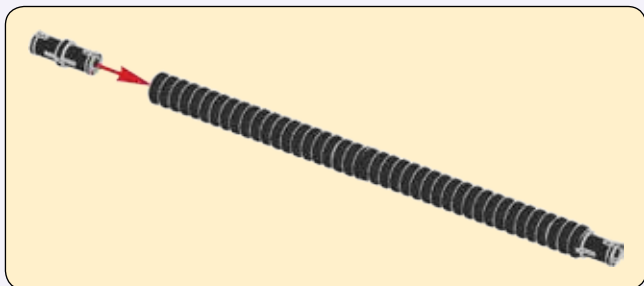

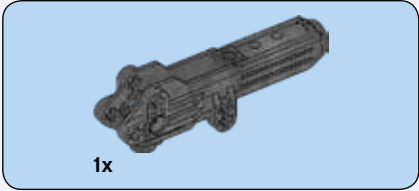

23

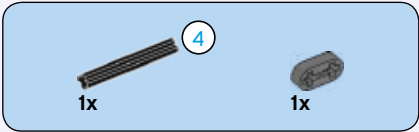
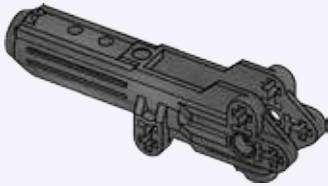

24

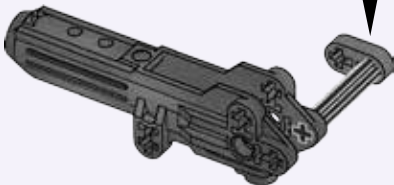
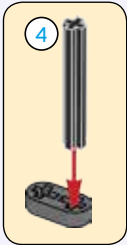



1x



1x



1x

# 25

1

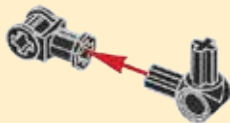

2

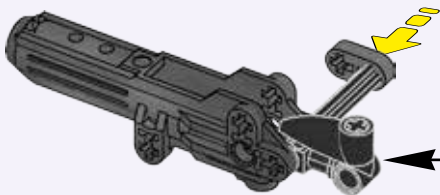

1x

# 26



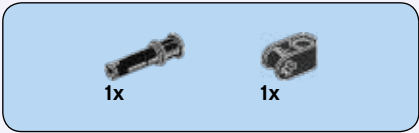

27

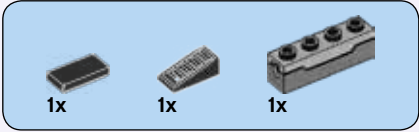
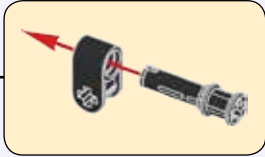

28

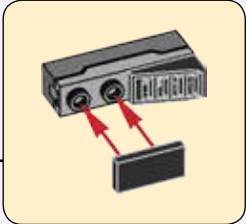
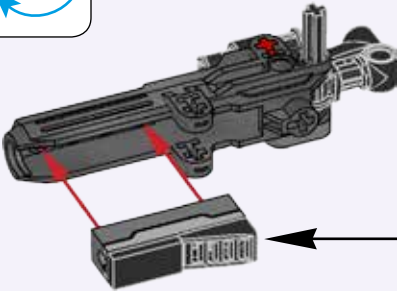



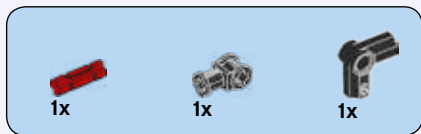

# 29

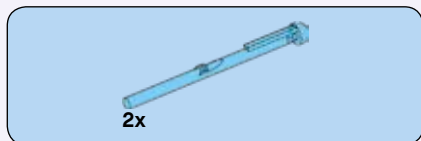
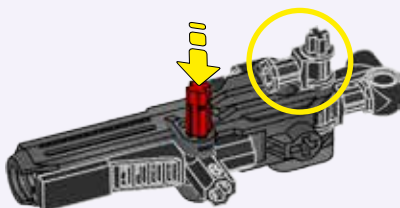

# 30

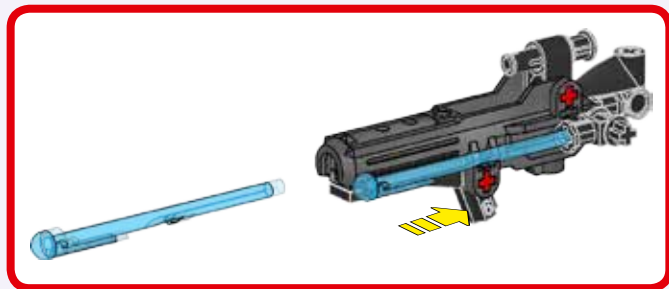
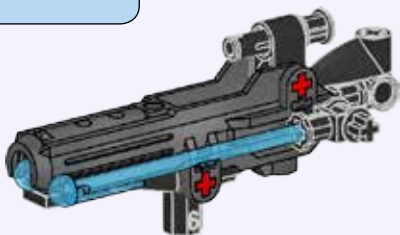



1x

# 31

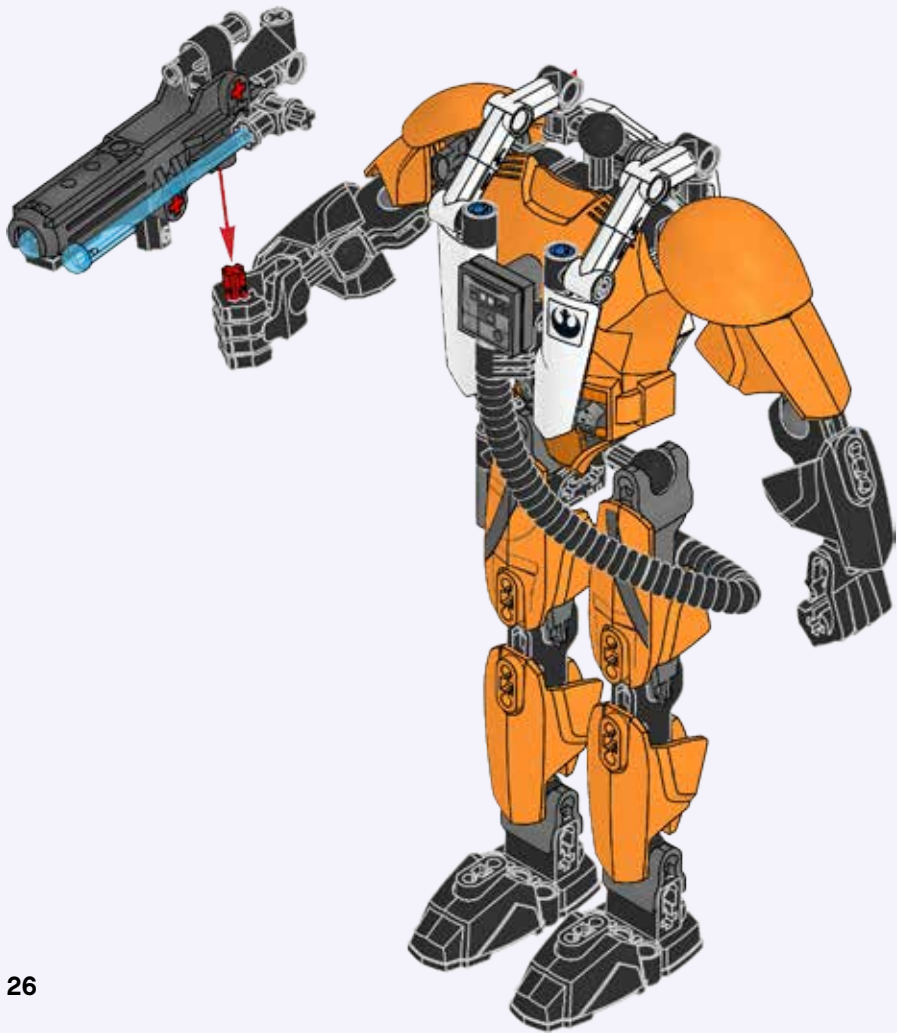



1x

# 32

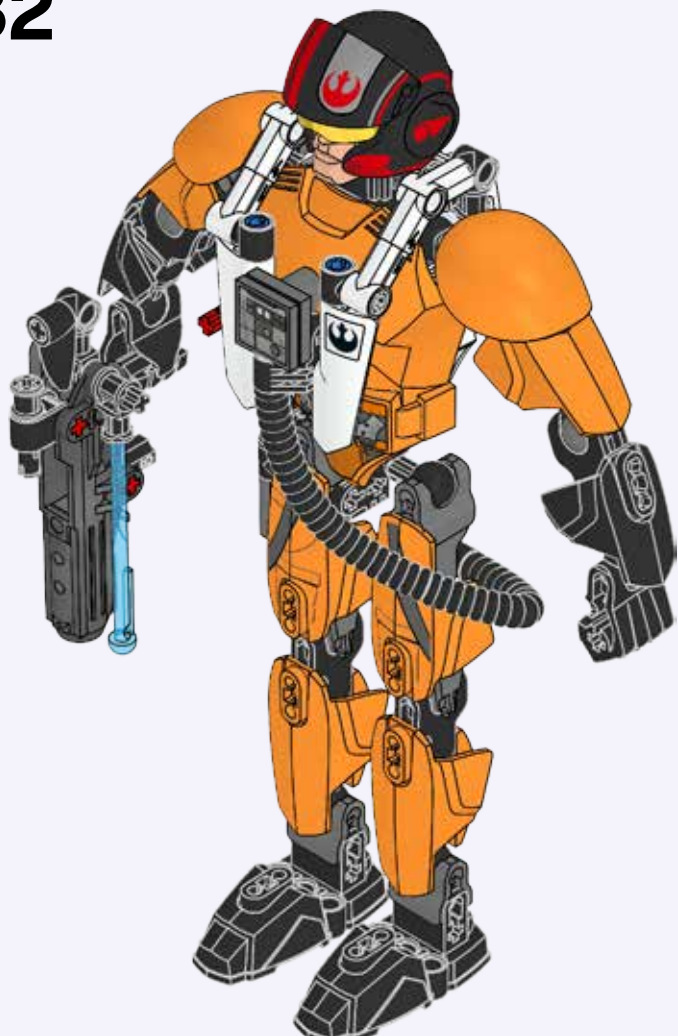



## Customer Service

Kundenservice

Service Consommateurs

Servicio Al Consumidor

LEGO.com/service or dial



00800 5346 5555 :



1-800-422-5346 :





STAR  
WARS™



Disney

BUILDABLE  
FIGURES



# STAR WARS™



75113



75115



75116



**BUILDABLE  
FIGURES**



75114



75118



75117

Disney

# WIN

GO TO [WWW.LEGO.COM/PRODUCTFEEDBACK](http://WWW.LEGO.COM/PRODUCTFEEDBACK)  
AND GIVE US YOUR SHORT **FEEDBACK**  
ABOUT THIS LEGO® SET FOR A CHANCE  
TO WIN A COOL LEGO PRIZE.

## LEGO.com/productfeedback

### GEWINNE



Erzähle uns auf  
[www.LEGO.com/productfeedback](http://www.LEGO.com/productfeedback)

etwas über die Erfahrungen, die  
du mit diesem LEGO® Set gemacht  
hast, und sichere dir die Chance  
auf einen coolen LEGO Preis!

### 获取奖品



登录  
[www.LEGO.com/productfeedback](http://www.LEGO.com/productfeedback)

给出关于此乐高®套装的简短反馈，  
就有机会获得炫酷乐高奖品

### GAGNE



Rends-toi sur  
[www.LEGO.com/productfeedback](http://www.LEGO.com/productfeedback)

et donne-nous quelques com-  
mentaires sur ce produit LEGO®  
pour avoir une chance de gagner  
un prix LEGO !

### 경품 당첨 기회



[www.LEGO.com/productfeedback](http://www.LEGO.com/productfeedback)

페이지로 이동하여 이 레고® 세트에  
대한 간단한 피드백을 보내 주시고  
멋진 레고 경품을 탈 수 있는 기회도  
잡으십시오

### GANA



Visita  
[www.LEGO.com/productfeedback](http://www.LEGO.com/productfeedback)

y envíanos tu opinión acerca de  
este set LEGO®. ¡Participarás en el  
sorteo de un premio LEGO!

### ЗАПОЛНИ АНКЕТУ И ПОЛУЧИ ПРИЗ



Перейди по ссылке  
[www.LEGO.com/productfeedback](http://www.LEGO.com/productfeedback)

ответь всего на несколько во-  
просов об этом наборе LEGO®,  
и у тебя появится шанс выиграть  
замечательный приз от компа-  
нии LEGO.