

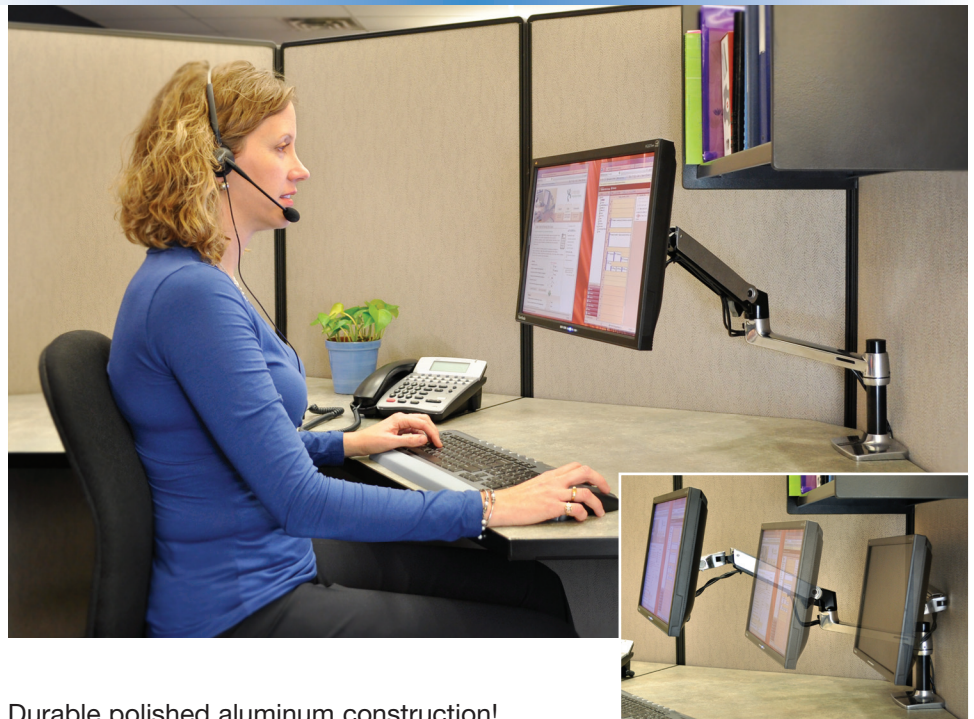

Ergotron® LX

Desk and Wall Mount LCD Arms



Highlights



- Increase viewing comfort—help reduce eye, back and neck strain
- Upgrade LCD monitors and TVs with improved ergonomic adjustment
- Patented CF motion technology provides premium ease-of-use display adjustment
- Cable management feature routes cables under the arm, out of the way
- 13" (33 cm) height range meets the ergonomic needs of more than nine out of ten adults
- Compact design frees up space. Arm folds back over the base into a compact retracted position; perfect for tucking under systems furniture storage shelves or cabinets in space constrained areas
- Passes Ergotron's 10,000-cycle motion test, which ensures a minimum of five years trouble-free height adjustment
- Complies with all international environmental regulations related to its design, manufacture and packaging. Read more about our Environmentally Responsible Process on our website

Durable polished aluminum construction!

Ergotron's LX LCD Arms include Constant Force (CF) patented lift-and-pivot motion technology. With a light touch of your hand you can easily lift, swing, tilt or turn your display.

- Increase viewing comfort—help reduce eye, back and neck strain
- Reposition your display with just a touch
- Excellent price performance
- Arm extends LCD up to 25" (64 cm) and 34" (86 cm) when a second extension is used—push it back out of the way
- Wall Mount or Desk Mount installation

The LX LCD Arm is the perfect desk or wall mount accessory to add flexibility and superior ergonomics to your LCD monitor or TV. Sleek and streamlined, it frees up space and allows you to easily position your display for greater productivity. It's ideal for home and office use, especially in situations where several people use the same display.



Position your display for maximum ergonomic comfort to relieve eye, neck and back strain

Free up your table or desktop to increase your workspace

Rotate screen for portrait viewing of photos and pages—eliminate scrolling

Easy-to-use, simple installation and effortless operation

The sleek and elegant design of the LX arm embellishes your desk and makes your office into a more enjoyable working environment

Save costs by improving the health of the workforce due to reduced neck and back strain

Adjustment range of the LX Arm allows LCD to be lowered into a position that is comfortable for people wearing bifocals or using a tablet PC

LX LCD Arm can be used without its extension or with a second 9" extension

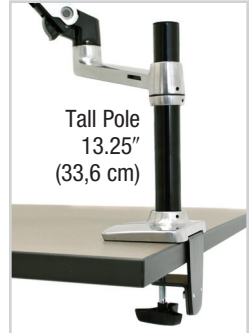

Typical LCD Size	LCD Weight*	Lift	Tilt	Pan	Rotation	VESA
≤ 24"	7–20 lbs 3,1–9,1 kg	13" 33 cm	75°	360°	360° P/L	MIS-D

* Monitor depth greater than 2" (5 cm) may diminish weight capacity

Product Name	LX Desk Mount LCD Arm 45-241-026 (polished aluminum)	LX Wall Mount LCD Arm 45-243-026 (polished aluminum)
Part Number	LX Desk Mount LCD Arm, Tall Pole 45-295-026 (polished aluminum)	
Product Includes	LX arm, extension, desk clamp and grommet mount bases	LX arm, extension, wall mount
	Add Notebook Tray (ordered separately, 50-193-200) to hold laptops and convertible notebooks	
Attachment Options	Desk clamp attaches to surface edge .4–2.4" (10–60 mm) thick; grommet mount attaches through surface hole .31–2" (8–50 mm) wide and up to 3" (76 mm) thick	Attach directly to sturdy vertical surface Wall track recommended (order separately)
Shipping Dimensions	45-241-026: 25.5"H x 11.25"W x 7.25"D (65 x 29 x 18 cm) 45-295-026: 23"H x 11.25"W x 6.5"D (58,5 x 28,5 x 16,7 cm)	20.75"H x 11.25"W x 7.5"D (53 x 29 x 19 cm)
Shipping Weight	45-241-026: 9.75 lbs (4,4 kg) 45-295-026: 11 lbs (5 kg)	7.0 lbs (3,2 kg)
Warranty	5 years	
Weight Capacity	7–20 lbs (3,1–9,1 kg) Monitor depth greater than 2" (5 cm) may diminish capacity System weight capacity is reduced by using two extensions, see installation manual or website for details LX Extension 45-244-026 (polished aluminum) Not compatible with LX Dual Desk Mount Arms (45-245-026, 45-248-026)	
Compatible Display(s)	VESA MIS-D compatible displays up to 20 lbs (9,1 kg)	

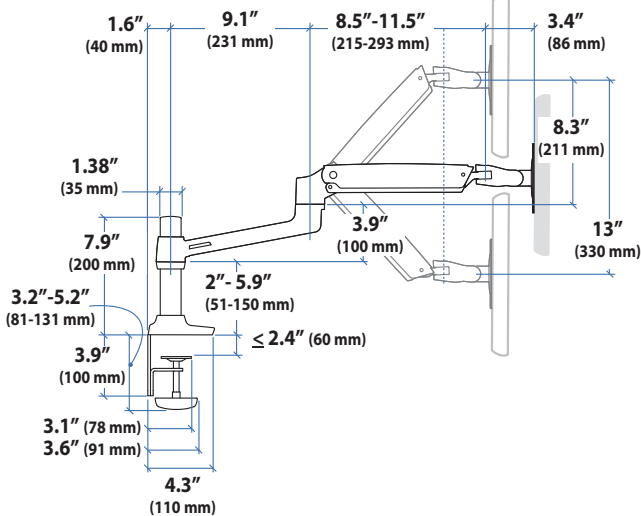

© 2011 Ergotron, Inc. rev. 09/27/2011 e-05-056 Content is subject to change without notification.

Americas Sales and Corporate Headquarters

St. Paul, MN USA
(800) 888-8458
+1-651-681-7600
www.ergotron.com
sales@ergotron.com

EMEA Sales

Amersfoort, The Netherlands
+31 33 45 45 600
www.ergotron.com
info.eu@ergotron.com

APAC Sales

Tokyo, Japan
www.ergotron.com
apaccustomerservice@ergotron.com

Worldwide OEM Sales

www.ergotron.com
info.oem@ergotron.com

