



Cisco SFP and SFP+ Transceiver Module Installation Notes

Revised: September 13, 2012

Product Numbers:	SFP-10G-SR=	SFP-10G-LR=	SFP-10G-LRM=	SFP-OC48-LR2=
	SFP-GE-Z=	SFP-OC3-MM=	SFP-OC3-SR=	SFP-OC12-LR2=
	SFP-OC3-LR2=	SFP-GE-L=	SFP-OC12-SR=	GLC-SX-MM-RGD=
	SFP-OC3-LR1=	SFP-OC48-SR=	SFP-OC48-IR1=	GLC-ZX-SM-RGD=
	SFP-GE-S=	GLC-SX-MM=	SFP-OC3-IR1=	GLC-FE-100FX=
	GLC-ZX-SM=	SFP-OC12-IR1=	GLC-T=	GLC-FE-100FX-RGD=
	GLC-LH-SM=	GLC-BX-D=	GLC-BX-U=	GLC-FE-100BX-D=
	GLC-FE-100BX-U=	GLC-FE-100EX=	GLC-FE-100LX=	GLC-FE-100ZX=
	SFP-H10GB-CU1M=	SFP-H10GB-CU3M=	SFP-H10GB-CU5M=	SFP-10G-ER=
	SFP-OC12-MM=	DWDM-SFP-xxxx=	SFP-OC12-LR1=	CWDM-SFP-xxxx=
	GLC-LX-SM-RGD=	GLC-GE-100FX=	GLC-FE-100LX-RGD=	GLC-EX-SMD=
	SFP-H10GB-ACU7M=	SFP-H10GB-ACU10M=	GLC-SX-MMD=	GLC-LH-SMD=
	GLC-2BX-D=	SFP-10G-ZR=	SFP-10G-SR-X=	SFP-10G-LR-X=
	SFP-H10GB-CU1-5M=	SFP-H10GB-CU2M=	SFP-H10GB-CU2-5M=	SFP-10G-AOC1=
	SFP-10G-AOC2M=	SFP-10G-AOC3M=	SFP-10G-AOC5M=	SFP-10G-AOC7M=
	SFP-10G-AOC10M=	DWDM-SFP10G-xx.xx=	GLC-ZX-SMD=	

This installation note provides the installation instructions for the Cisco small form-factor pluggable (SFP) and SFP+ transceiver modules. These transceiver modules are hot-swappable input/output (I/O) devices that plug into 100BASE, 1000BASE and 10GBASE ports (for SFP+), which connect the module port with the fiber-optic or copper network.



Americas Headquarters:
Cisco Systems, Inc., 170 West Tasman Drive, San Jose, CA 95134-1706 USA

Contents

This document contains these sections:

- [Overview, page 2](#)
- [Safety, page 17](#)
- [Required Tools, page 22](#)
- [Installing SFP and SFP+ Transceiver Modules, page 23](#)
- [Removing SFP and SFP+ Transceiver Modules, page 28](#)
- [Obtaining Documentation and Submitting a Service Request, page 36](#)

Overview

The SFP transceiver modules are hot-pluggable I/O devices that plug into module sockets. The transceiver connects the electrical circuitry of the module with the optical or copper network.

You can use any combination of SFP transceiver modules that your Cisco device supports. The only restrictions are that each port must match the wavelength specifications on the other end of the cable and that the cable must not exceed the stipulated cable length for reliable communications.

Use only Cisco SFP transceiver modules on your Cisco device. Each SFP transceiver module supports the Cisco Quality Identification (ID) feature which allows a Cisco switch or router to identify and validate that the transceiver module is certified and tested by Cisco.

An optical SFP transceiver module is shown in [Figure 1](#).

Figure 1 SFP Transceiver Module (Fiber-Optic LC Connector)

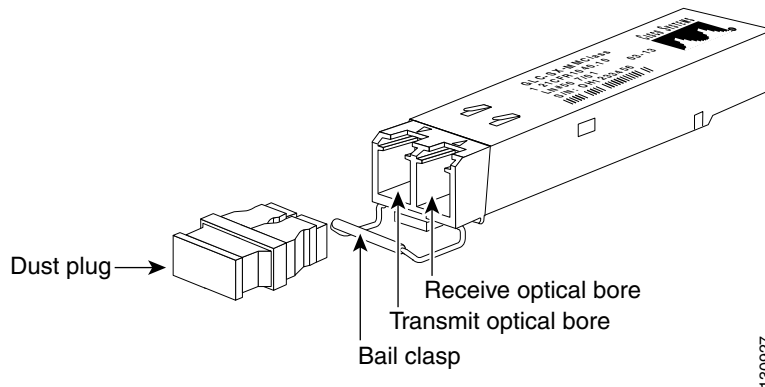

Note

SFP transceiver modules that operate with single-strand SMF, have only one optical bore; the other bore is blocked off.

A copper SFP transceiver module is shown in [Figure 2](#).

Figure 2 1000BASE-T SFP Transceiver Module (RJ-45 Connector)

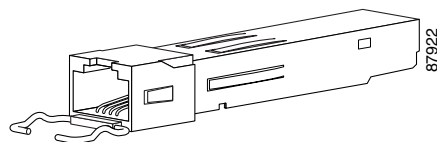

An SFP+ transceiver module is shown in [Figure 3](#).

Figure 3 SFP+ Transceiver Module (Fiber-Optic LC Connector)

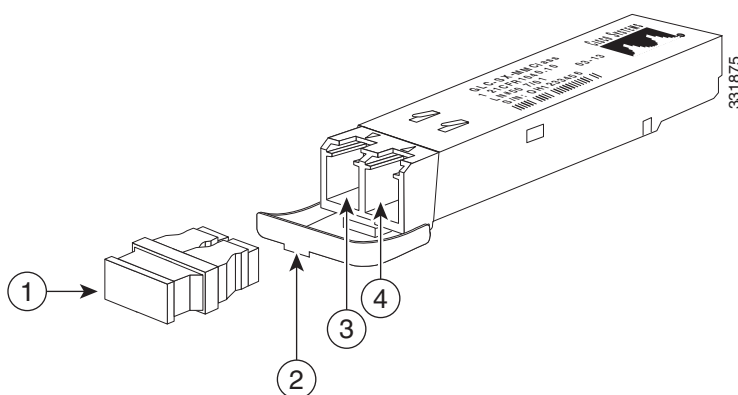

1	Dust plug	3	Transmit bore
2	Bail clasp with clasp tab	4	Receive bore

The product numbers and brief description of the SFP and SFP+ transceiver modules are listed in [Table 1](#).

Table 1 Product Numbers and Descriptions

SFP Transceiver Module Product Number	Transceiver Description
10-Gigabit Ethernet	
SFP-10G-SR	Cisco 10GBASE-SR SFP+ transceiver module for MMF, 850-nm wavelength
SFP-10G-SR-X	Cisco 10GBASE-SR SFP+ transceiver module for MMF, 850-nm wavelength, extended temperature range
SFP-10G-LR	Cisco 10GBASE-LR SFP+ transceiver module for SMF, 1310-nm wavelength
SFP-10G-LR-X	Cisco multirate 10GBASE-LR/10GBASE-LW/OTU2e SFP+ transceiver module for SMF, 1310-nm wavelength, extended temperature range
SFP-10G-LRM	Cisco 10GBASE-LRM SFP+ transceiver module for MMF and SMF, 1310-nm wavelength
SFP-10G-ER	Cisco 10GBASE-ER SFP+ transceiver module for SMF, 1550-nm wavelength
SFP-10G-ZR	Cisco 10GBASE-ZR SFP+ transceiver module for SMF, 1550-nm wavelength

Table 1 Product Numbers and Descriptions (continued)

SFP Transceiver Module Product Number	Transceiver Description
SFP-H10GB-CU1M	Cisco 10GBASE-CU passive Twinax SFP+ cable assembly, 1 meter
SFP-H10GB-CU1-5M	Cisco 10GBASE-CU passive Twinax SFP+ cable assembly, 1.5 meters
SFP-H10GB-CU2M	Cisco 10GBASE-CU passive Twinax SFP+ cable assembly, 2 meters
SFP-H10GB-CU2-5M	Cisco 10GBASE-CU passive Twinax SFP+ cable assembly, 2.5 meters
SFP-H10GB-CU3M	Cisco 10GBASE-CU passive Twinax SFP+ cable assembly, 3 meters
SFP-H10GB-CU5M	Cisco 10GBASE-CU passive Twinax SFP+ cable assembly, 5 meters
SFP-H10GB-ACU7M	Cisco 10GBASE-CU active Twinax SFP+ cable assembly, 7 meters
SFP-H10GB-ACU10M	Cisco 10GBASE-CU active Twinax SFP+ cable assembly, 10 meters
SFP-10G-AOC1M	Cisco 10GBASE-AOC Active Optical Cable SFP+ assembly, 1 meter
SFP-10G-AOC2M	Cisco 10GBASE-AOC Active Optical Cable SFP+ assembly, 2 meters
SFP-10G-AOC3M	Cisco 10GBASE-AOC Active Optical Cable SFP+ assembly, 3 meters
SFP-10G-AOC5M	Cisco 10GBASE-AOC Active Optical Cable SFP+ assembly, 5 meters
SFP-10G-AOC7M	Cisco 10GBASE-AOC Active Optical Cable SFP+ assembly, 7 meters
SFP-10G-AOC10M	Cisco 10GBASE-AOC Active Optical Cable SFP+ assembly, 10 meters
1-Gigabit Ethernet	
GLC-SX-MM=	Cisco 1000BASE-SX SFP transceiver module for MMF, 850-nm wavelength, commercial operating temperature range.
GLC-SX-MM-RGD=	Cisco 1000BASE-SX SFP transceiver module for MMF, 850-nm wavelength, industrial operating temperature range.
SFP-GE-S=	Cisco 1000BASE-SX SFP transceiver module for MMF, 850-nm wavelength, extended operating temperature range.
GLC-SX-MMD=	Cisco 1000BASE-SX SFP transceiver module for MMF, 850-nm wavelength, extended operating temperature range.
GLC-LH-SM=	Cisco 1000BASE-LX/LH SFP transceiver module for MMF and SMF, 1300-nm wavelength, commercial operating temperature range.
GLC-LX-SM-RGD=	Cisco 1000BASE-LX/LH SFP transceiver module for MMF and SMF, 1300-nm wavelength, industrial operating temperature range.
SFP-GE-L=	Cisco 1000BASE-LX/LH SFP transceiver module for MMF and SMF, 1300-nm wavelength, extended operating temperature range.
GLC-LH-SMD=	Cisco 1000BASE-LX/LH SFP transceiver module for MMF and SMF, 1300-nm wavelength, extended operating temperature range.
GLC-EX-SMD=	Cisco 1000BASE-EX SFP transceiver module for SMF, 1310-nm wavelength, extended operating temperature range.
GLC-ZX-SM=	Cisco 1000BASE-ZX SFP transceiver module for SMF, 1550-nm wavelength, commercial operating temperature range.
GLC-ZX-SM-RGD=	Cisco 1000BASE-ZX SFP transceiver module for SMF, 1550-nm wavelength, industrial operating temperature range.
SFP-GE-Z=	Cisco 1000BASE-ZX SFP transceiver module for SMF, 1550-nm wavelength, extended operating temperature range.

Table 1 **Product Numbers and Descriptions (continued)**

SFP Transceiver Module Product Number	Transceiver Description
GLC-ZX-SMD=	Cisco 1000BASE-ZX SFP transceiver module for SMF, 1550-nm wavelength, extended operating temperature range.
GLC-T=	1000BASE-T SFP transceiver module for copper networks, commercial operating temperature range.
SFP-GE-T=	1000BASE-T SFP transceiver module for copper networks, extended operating temperature range.
GLC-BX-D=	1000BASE-BX10 SFP module for single-strand SMF, 1490-nm TX/1310-nm RX wavelength, commercial operating temperature range.
GLC-BX-U=	1000BASE-BX10 SFP module for single-strand SMF, 1310-nm TX/1490-nm RX wavelength, commercial operating temperature range.
GLC-2BX-D=	Dual-channel 1000BASE-BX10 SFP module for single-strand SMF, 1490-nm TX/1310-nm RX wavelength, commercial operating temperature range.
Fast Ethernet	
GLC-FE-100FX=	100BASE-FX SFP module for 100-Mb ports, MMF, 1310-nm wavelength, commercial operating temperature range.
GLC-FE-100FX-RGD=	100BASE-FX SFP module for 100-Mb ports, MMF, 1310-nm wavelength, industrial operating temperature range.
GLC-GE-100FX=	100BASE-FX SFP module for Gigabit Ethernet ports, MMF, 1310-nm wavelength, commercial operating temperature range.
GLC-FE-100LX=	100BASE-LX10 SFP module for 100-Mb ports, SMF, 1310-nm wavelength, commercial operating temperature range.
GLC-FE-100LX-RGD=	100BASE-LX10 SFP module for 100-Mb ports, SMF, 1310-nm wavelength, industrial operating temperature range.
GLC-FE-100BX-D=	100BASE-BX10-D SFP module for single-strand SMF, 1550-nm TX/1310-nm RX wavelength, commercial operating temperature range.
GLC-FE-100BX-U=	100BASE-BX10-U SFP module for single-strand SMF, 1310-nm TX/1550-nm RX wavelength, commercial operating temperature range.
GLC-FE-100EX=	100BASE-EX SFP module for 100-Mb ports, SMF, 1310-nm wavelength, commercial operating temperature range.
GLC-FE-100ZX=	100BASE-ZX SFP module for 100-Mb ports, SMF, 1550-nm wavelength, commercial operating temperature range.

Table 1 Product Numbers and Descriptions (continued)

SFP Transceiver Module Product Number	Transceiver Description
SONET/SDH	
SFP-OC3-MM	SFP OC-3/STM-1 Multimode
SFP-OC3-SR	SFP OC-3/STM-1 Short-Reach
SFP-OC3-IR1	SFP OC-3/STM-1 Intermediate-Reach
SFP-OC3-LR1	SFP OC-3/STM-1 Long-Reach (40 km)
SFP-OC3-LR2	SFP OC-3/STM-1 Long-Reach (80 km)
SFP-OC12-MM	SFP OC-12/STM-4 Multimode
SFP-OC12-SR	SFP OC-12/STM-4 Short-Reach
SFP-OC12-IR1	SFP OC-12/STM-4 Intermediate-Reach
SFP-OC12-LR1	SFP OC-12/STM-4 Long-Reach (40 km)
SFP-OC12-LR2	SFP OC-12/STM-4 Long-Reach (80 km)
SFP-OC48-SR	SFP OC-48/STM-16 Short-Reach
SFP-OC48-IR1	SFP OC-48/STM-16 Intermediate-Reach
SFP-OC48-LR2	SFP OC-48/STM-16 Long-Reach (80 km)
CWDM (OC-12/STM4, 1-Gigabit Ethernet, 1-Gigabit Fiber Channel, 2-Gigabit Fiber Channel, OC-48/STM-16)	
CWDM-SFP-1470=	Longwave 1470-nm laser, single mode
CWDM-SFP-1490=	Longwave 1490-nm laser, single mode
CWDM-SFP-1510=	Longwave 1510-nm laser, single mode
CWDM-SFP-1530=	Longwave 1530-nm laser, single mode
CWDM-SFP-1550=	Longwave 1550-nm laser, single mode
CWDM-SFP-1570=	Longwave 1570-nm laser, single mode
CWDM-SFP-1590=	Longwave 1590-nm laser, single mode
CWDM-SFP-1610=	Longwave 1610-nm laser, single mode
DWDM (OC-12/STM4, 1-Gigabit Ethernet, 1-Gigabit Fibre Channel, 2-Gigabit Fibre Channel, OC-48/STM-16)	
DWDM-SFP-6141=	Longwave 1561.42-nm laser (100-GHz ITU channel 20), single mode
DWDM-SFP-6061=	Longwave 1560.61-nm laser (100-GHz ITU channel 21), single mode
DWDM-SFP-5979=	Longwave 1559.79-nm laser (100-GHz ITU channel 22), single mode
DWDM-SFP-5898=	Longwave 1558.98-nm laser (100-GHz ITU channel 23), single mode
DWDM-SFP-5817=	Longwave 1558.17-nm laser (100-GHz ITU channel 24), single mode
DWDM-SFP-5736=	Longwave 1557.36-nm laser (100-GHz ITU channel 25), single mode
DWDM-SFP-5655=	Longwave 1556.55-nm laser (100-GHz ITU channel 26), single mode
DWDM-SFP-5575=	Longwave 1555.75-nm laser (100-GHz ITU channel 27), single mode
DWDM-SFP-5494=	Longwave 1554.94-nm laser (100-GHz ITU channel 28), single mode
DWDM-SFP-5413=	Longwave 1554.13-nm laser (100-GHz ITU channel 29), single mode

Table 1 **Product Numbers and Descriptions (continued)**

SFP Transceiver Module Product Number	Transceiver Description
DWDM-SFP-5332=	Longwave 1553.33-nm laser (100-GHz ITU channel 30), single mode
DWDM-SFP-5252=	Longwave 1552.52-nm laser (100-GHz ITU channel 31), single mode
DWDM-SFP-5172=	Longwave 1551.72-nm laser (100-GHz ITU channel 32), single mode
DWDM-SFP-5092=	Longwave 1550.92-nm laser (100-GHz ITU channel 33), single mode
DWDM-SFP-5012=	Longwave 1550.12-nm laser (100-GHz ITU channel 34), single mode
DWDM-SFP-4931=	Longwave 1549.32-nm laser (100-GHz ITU channel 35), single mode
DWDM-SFP-4851=	Longwave 1548.51-nm laser (100-GHz ITU channel 36), single mode
DWDM-SFP-4772=	Longwave 1547.72-nm laser (100-GHz ITU channel 37), single mode
DWDM-SFP-4692=	Longwave 1546.92-nm laser (100-GHz ITU channel 38), single mode
DWDM-SFP-4612=	Longwave 1546.12-nm laser (100-GHz ITU channel 39), single mode
DWDM-SFP-4532=	Longwave 1545.32-nm laser (100-GHz ITU channel 40), single mode
DWDM-SFP-4453=	Longwave 1544.53-nm laser (100-GHz ITU channel 41), single mode
DWDM-SFP-4373=	Longwave 1543.73-nm laser (100-GHz ITU channel 42), single mode
DWDM-SFP-4294=	Longwave 1542.94-nm laser (100-GHz ITU channel 43), single mode
DWDM-SFP-4214=	Longwave 1542.14-nm laser (100-GHz ITU channel 44), single mode
DWDM-SFP-4134=	Longwave 1541.35-nm laser (100-GHz ITU channel 45), single mode
DWDM-SFP-4056=	Longwave 1540.56-nm laser (100-GHz ITU channel 46), single mode
DWDM-SFP-3977=	Longwave 1539.77-nm laser (100-GHz ITU channel 47), single mode
DWDM-SFP-3898=	Longwave 1538.98-nm laser (100-GHz ITU channel 48), single mode
DWDM-SFP-3819=	Longwave 1538.19-nm laser (100-GHz ITU channel 49), single mode
DWDM-SFP-3739=	Longwave 1537.40-nm laser (100-GHz ITU channel 50), single mode
DWDM-SFP-3661=	Longwave 1536.61-nm laser (100-GHz ITU channel 51), single mode
DWDM-SFP-3582=	Longwave 1535.82-nm laser (100-GHz ITU channel 52), single mode
DWDM-SFP-3504=	Longwave 1535.04-nm laser (100-GHz ITU channel 53), single mode
DWDM-SFP-3425=	Longwave 1534.25-nm laser (100-GHz ITU channel 54), single mode
DWDM-SFP-3346=	Longwave 1533.47-nm laser (100-GHz ITU channel 55), single mode
DWDM-SFP-3268=	Longwave 1532.68-nm laser (100-GHz ITU channel 56), single mode
DWDM-SFP-3190=	Longwave 1531.90-nm laser (100-GHz ITU channel 57), single mode
DWDM-SFP-3112=	Longwave 1531.12-nm laser (100-GHz ITU channel 58), single mode
DWDM-SFP-3033=	Longwave 1530.33-nm laser (100-GHz ITU channel 59), single mode

Table 1 *Product Numbers and Descriptions (continued)*

SFP Transceiver Module Product Number	Transceiver Description
10-Gigabit DWDM SFP+ (10G LAN, 10G WAN, OTU2/OTU2e)	
DWDM-SFP10G-61.41=	10GBASE-DWDM 1561.41-nm SFP+ (100-GHz ITU grid)
DWDM-SFP10G-60.61=	10GBASE-DWDM 1560.61-nm SFP+ (100-GHz ITU grid)
DWDM-SFP10G-59.79=	10GBASE-DWDM 1559.79-nm SFP+ (100-GHz ITU grid)
DWDM-SFP10G-58.98=	10GBASE-DWDM 1558.98-nm SFP+ (100-GHz ITU grid)
DWDM-SFP10G-58.17=	10GBASE-DWDM 1558.17-nm SFP+ (100-GHz ITU grid)
DWDM-SFP10G-57.36=	10GBASE-DWDM 1557.36-nm SFP+ (100-GHz ITU grid)
DWDM-SFP10G-56.55=	10GBASE-DWDM 1556.55-nm SFP+ (100-GHz ITU grid)
DWDM-SFP10G-55.75=	10GBASE-DWDM 1555.75-nm SFP+ (100-GHz ITU grid)
DWDM-SFP10G-54.94=	10GBASE-DWDM 1554.94-nm SFP+ (100-GHz ITU grid)
DWDM-SFP10G-54.13=	10GBASE-DWDM 1554.13-nm SFP+ (100-GHz ITU grid)
DWDM-SFP10G-53.33=	10GBASE-DWDM 1553.33-nm SFP+ (100-GHz ITU grid)
DWDM-SFP10G-52.52=	10GBASE-DWDM 1552.52-nm SFP+ (100-GHz ITU grid)
DWDM-SFP10G-51.72=	10GBASE-DWDM 1551.72-nm SFP+ (100-GHz ITU grid)
DWDM-SFP10G-50.92=	10GBASE-DWDM 1550.92-nm SFP+ (100-GHz ITU grid)
DWDM-SFP10G-50.12=	10GBASE-DWDM 1550.12-nm SFP+ (100-GHz ITU grid)
DWDM-SFP10G-49.32=	10GBASE-DWDM 1549.32-nm SFP+ (100-GHz ITU grid)
DWDM-SFP10G-48.51=	10GBASE-DWDM 1548.51-nm SFP+ (100-GHz ITU grid)
DWDM-SFP10G-47.72=	10GBASE-DWDM 1547.72-nm SFP+ (100-GHz ITU grid)
DWDM-SFP10G-46.92=	10GBASE-DWDM 1546.92-nm SFP+ (100-GHz ITU grid)
DWDM-SFP10G-46.12=	10GBASE-DWDM 1546.12-nm SFP+ (100-GHz ITU grid)
DWDM-SFP10G-45.32=	10GBASE-DWDM 1545.32-nm SFP+ (100-GHz ITU grid)
DWDM-SFP10G-44.53=	10GBASE-DWDM 1544.53-nm SFP+ (100-GHz ITU grid)

Table 1 **Product Numbers and Descriptions (continued)**

SFP Transceiver Module Product Number	Transceiver Description
DWDM-SFP10G-43.73=	10GBASE-DWDM 1543.73-nm SFP+ (100-GHz ITU grid)
DWDM-SFP10G-42.94=	10GBASE-DWDM 1542.94-nm SFP+ (100-GHz ITU grid)
DWDM-SFP10G-42.14=	10GBASE-DWDM 1542.12-nm SFP+ (100-GHz ITU grid)
DWDM-SFP10G-41.35=	10GBASE-DWDM 1541.35-nm SFP+ (100-GHz ITU grid)
DWDM-SFP10G-40.56=	10GBASE-DWDM 1540.56-nm SFP+ (100-GHz ITU grid)
DWDM-SFP10G-39.77=	10GBASE-DWDM 1539.77-nm SFP+ (100-GHz ITU grid)
DWDM-SFP10G-38.98=	10GBASE-DWDM 1538.98-nm SFP+ (100-GHz ITU grid)
DWDM-SFP10G-38.19=	10GBASE-DWDM 1538.19-nm SFP+ (100-GHz ITU grid)
DWDM-SFP10G-37.40=	10GBASE-DWDM 1537.40-nm SFP+ (100-GHz ITU grid)
DWDM-SFP10G-36.61=	10GBASE-DWDM 1536.61-nm SFP+ (100-GHz ITU grid)
DWDM-SFP10G-35.82=	10GBASE-DWDM 1535.82-nm SFP+ (100-GHz ITU grid)
DWDM-SFP10G-35.04=	10GBASE-DWDM 1535.04-nm SFP+ (100-GHz ITU grid)
DWDM-SFP10G-34.25=	10GBASE-DWDM 1534.25-nm SFP+ (100-GHz ITU grid)
DWDM-SFP10G-33.47=	10GBASE-DWDM 1533.47-nm SFP+ (100-GHz ITU grid)
DWDM-SFP10G-32.68=	10GBASE-DWDM 1532.68-nm SFP+ (100-GHz ITU grid)
DWDM-SFP10G-31.90=	10GBASE-DWDM 1531.90-nm SFP+ (100-GHz ITU grid)
DWDM-SFP10G-31.12=	10GBASE-DWDM 1531.12-nm SFP+ (100-GHz ITU grid)
DWDM-SFP10G-30.33=	10GBASE-DWDM 1530.33-nm SFP+ (100-GHz ITU grid)

The SFP+ and SFP transceiver module cabling and optical transmit and receive specifications are listed in Table 2 through Table 9.

Table 2 SFP+ Optical Transceiver Module Cabling Specifications

SFP+ Transceiver Module Model	Wavelength (nm)	Fiber Type	Core Size (µm) ¹	Modal Bandwidth (MHz/km) ²	Cable Distance (ft/m)
SFP-10G-SR SFP-10G-SR-X	850	MMF	62.5 62.5 50.0 50.0 50.0 50.0	160 (FDDI) 200 (OM1) 400 (400/400) 500 (OM2) 2000 (OM3) 4700 (OM4)	85/26 108/33 216/66 269/82 984/300 1312/400
SFP-10G-LR SFP-10G-LR-X	1310	SMF	G.652	—	6.2 miles (10 km)
SFP-10G-LRM	1310	MMF SMF	62.5 50.0 50.0 G.652	500 400 500 —	722/220 328/100 722/220 984/300
SFP-10G-ER	1550	SMF	G.652	—	24.86 miles (40 km) ³
SFP-10G-ZR	1550	SMF	G.652	—	49.72 miles (80 km)

1. G.652, listed under core size for single mode fiber (SMF), refers to a ITU-T standard of commonly deployed non-dispersion-shifted single mode fiber with a core size of approximately 8 to 10 microns (µm).
2. At specified wavelength.
3. For distances up to 30 km, no special link design rules need to be considered. Link distances beyond 30 km require that you verify the cable characteristics, especially the cable's loss value.

Table 3 SFP+ Transceiver Module Optical Transmit and Receive Specifications

SFP+ Transceiver Module Model	Transceiver Type	Transmit Power (dBm)	Receive Power (dBm)	Transmit and Receive Wavelength (nm)
SFP-10G-SR SFP-10G-SR-X	10GBASE-SR, 850-nm MMF	-1.3 (Max) -7.3 (Min)	-1.0 (Max) -9.9 (Min)	840 to 860
SFP-10G-LR SFP-10G-LR-X	10GBASE-LR, 1310-nm SMF	0.5 (Max) -8.2 (Min)	0.5 (Max) -14.4 (Min)	1260 to 1355
SFP-10G-LRM	10GBASE-LRM, 1310-nm MMF and SMF	0.5 (Max) -6.5 (Min)	0.5 (Max) -8.4 (Min average) -6.4 (Min in OMA)	1260 to 1355
SFP-10G-ER ¹	10GBASE-ER, 1550-nm SMF	4.0 (Max) -4.7 (Min)	-1.0 (Max) -15.8 (Min)	1530 to 1565
SFP-10G-ZR ²	10GBASE-ZR, 1550-nm SMF	4.0 (Max) 0 (Min) ³	-7.0 (Max) -24.0 (Min)	1530 to 1565

1. Requires a 5-dB, 1550-nm, fixed loss attenuator for distances less than 20 km.
2. Requires a 5- or 10-dB fixed loss attenuator for distances less than 40 km. Please keep receive power below -7 dBm.
3. Receiver sensitivity for 10G Ethernet links with no FEC. With FEC-capable receiver ports and for OTU2/OTU2e links, receiver sensitivity is improved to -27 dBm. Also a 3 dB dispersion penalty should be taken into account for both FEC and non-FEC cases.

Table 4 100-Mb and 1-Gigabit Optical SFP Transceiver Module Cabling Specifications

SFP Module Model	Wavelength (nanometers)	Fiber Type	Core Size (micron) ¹	Modal Bandwidth (MHz/km)	Cable Distance
GLC-SX-MM SFP-GE-S GLC-SX-MM-RGD GLC-SX-MMD	850	MMF	62.5 62.5 50.0 50.0 50.0	160 200 400 500 2000	722 feet (220 m) 902 feet (275 m) 1640 feet (500 m) 1804 feet (550 m) 3281 feet (1 km)
GLC-LH-SM SFP-GE-L GLC-LX-SM-RGD GLC-LH-SMD	1310	MMF ² SMF	62.5 50.0 50.0 G.652	500 400 500 —	1804 feet (550 m) 1804 feet (550 m) 1804 feet (550 m) 6.2 miles (10 km)
GLC-BX-D GLC-2BX-D	1490 (downstream)	SMF	G.652	—	6.2 miles (10 km)
GLC-BX-U	1310 (upstream)	SMF	G.652	—	6.2 miles (10 km)
GLC-EX-SMD	1310	SMF	G.652	—	24.9 miles (40 km)
GLC-ZX-SM GLC-ZX-SM-RGD SFP-GE-Z GLC-ZX-SMD	1550	SMF	G.652	—	43.4 to 62 miles (70 to 100 km)
GLC-FE-100FX GLC-FE-100FX-RGD	1310	MMF	62.5 62.5 50.0 50.0	160 200 400 500	1.24 miles (2 km)
GLC-FE-100LX GLC-FE-100LX-RGD	1310	SMF	G.652	—	6.2 miles (10 km)
GLC-FE-100BX-D	1550 (downstream)	SMF	G.652	—	6.2 miles (10 km)
GLC-FE-100BX-U	1310 (upstream)	SMF	G.652	—	6.2 miles (10 km)
GLC-FE-100EX	1310	SMF	G.652	—	24.9 miles (40 km)
GLC-FE-100ZX	1550	SMF	G.652	—	49.7 miles (80 km)

1. G.652, listed under core size for single mode fiber (SMF), refers to a ITU-T standard of commonly deployed non-dispersion-shifted single mode fiber with a core size of approximately 8 to 10 microns (µm).
2. A mode-conditioning patch cord is required at all times per IEEE specifications.



Note

For the GLC-ZX-SM, the minimum attenuation between the transmit bore (TX) and the receive bore (RX) is 8 dB. When using shorter distances of single-mode fiber cable, you might need to insert an inline optical attenuator in the link to avoid overloading the receiver.

Copper SFP transceiver modules can operate at 10, 100, or 1000 Mbps on some Cisco devices. To find the supported speeds for the 1000BASE-T SFP transceiver modules in your Cisco device, see the *Compatibility Matrix for 1000BASE-T Small Form-Factor Pluggable Modules*.

Copper 1000BASE-T SFP transceiver modules use standard four twisted-pair, Category 5 cable at lengths up to 328.08 feet (100 meters).

Table 5 100M and 1-Gigabit SFP Transceiver Module Optical Transmit and Receive Specifications

SFP Transceiver Module Model	Transceiver Type	Transmit Power (dBm)	Receive Power (dBm)	Transmit and Receive Wavelength (nm)
GLC-SX-MM SFP-GE-S GLC-SX-MM-RGD GLC-SX-MMD	1000BASE-SX, 850-nm MMF	-3 (Max) -9.5 (Min)	0 (Max) -17 (Min)	770 to 860
GLC-LH-SM SFP-GE-L GLC-LX-SM-RGD GLC-LH-SMD	1000BASE-LX/LH, 1310-nm SMF	-3 (Max) -9.5 (Min)	-3 (Max) -20 (Min)	1260 to 1355
GLC-BX-D GLC-2BX-D	1000BASE-BX-D, 1490-nm SMF	-3 (Max) -9 (Min)	-3 (Max) -19.5 (Min)	1480 to 1500 (transmit), 1260 to 1360 (receive)
GLC-BX-U	1000BASE-BX-U, 1310-nm SMF	-3 (Max) -9 (Min)	-3 (Max) -19.5 (Min)	1260 to 1360 (transmit), 1480 to 1500 (receive)
GLC-EX-SMD	1000BASE-EX, 1310 nm	+3 (Max) -1 (Min)	+1 (Max) -22 (Min)	1290 to 1335
GLC-ZX-SM GLC-ZX-SM-RGD SFP-GE-Z GLC-ZX-SMD	1000BASE-ZX, 1550 nm SMF	+5 (Max) 0 (Min)	-3 (Max) -23 (Min)	1500 to 1580
GLC-FE-100FX GLC-FE-100FX-RGD GLC-GE-100FX	100BASE-FX, 1310 nm MMF	-14 (Max) -20 (Min)	-14 (Max) -31 (Min)	1270 to 1380
GLC-FE-100LX GLC-FE-100LX-RGD	100BASE-LX, 1310 nm SMF	-8 (Max) -15 (Min)	-8 (Max) -28 (Min)	1260 to 1360
GLC-FE-100BX-D	100BASE-BX-D, 1550 nm SMF	-8 (Max) -14 (Min)	-3 (Max) -28.2 (Min)	1480 to 1580 (transmit), 1260 to 1360 (receive)
GLC-FE-100BX-U	100BASE-BX-U, 1310 nm SMF	-8 (Max) -14 (Min)	-3 (Max) -28.2 (Min)	1260 to 1360 (transmit), 1480 to 1580 (receive)
GLC-FE-100EX	100BASE-EX, 1310 nm SMF	0 (Max) -5 (Min)	-8 (Max) -28 (Min)	1260 to 1360
GLC-FE-100ZX	100BASE-ZX, 1550 nm SMF	+2 (Max) -3 (Min)	-8 (Max) -30 (Min)	1480 to 1600

Table 6 SONET/SDH Optical SFP Transceiver Module Cabling Specifications

SFP Module Model	Wavelength (nanometers)	Fiber Type	Core Size (micron) ¹	Modal Bandwidth (MHz/km)	Cable Distance
SFP-OC3-MM	1310	MMF	62.5 50.0	500 500	1.24 miles (2 km) 1.24 miles (2 km)
SFP-OC3-SR	1310	SMF	G.652	—	1.24 miles (2 km)
SFP-OC3-IR1	1310	SMF	G.652	—	9.3 miles (15 km)
SFP-OC3-LR1	1310	SMF	G.652	—	24.9 miles (40 km)
SFP-OC3-LR2	1550	SMF	G.652	—	49.7 miles (80 km)
SFP-OC12-MM	1310	MMF	62.5 50.0	500 500	1640 feet (500 m) 1640 feet (500 m)
SFP-OC12-SR	1310	SMF	G.652	—	1.24 miles (2 km)
SFP-OC12-IR1	1310	SMF	G.652	—	9.3 miles (15 km)
SFP-OC12-LR1	1310	SMF	G.652	—	24.9 miles (40 km)
SFP-OC12-LR2	1550	SMF	G.652	—	49.7 miles (80 km)
SFP-OC48-SR	1310	SMF	G.652	—	1.24 miles (2 km)
SFP-OC48-IR1	1310	SMF	G.652	—	9.3 miles (15 km)
SFP-OC48-LR2	1550	SMF	G.652	—	49.7 miles (80 km)

1. G.652, listed under core size for single mode fiber (SMF), refers to a ITU-T standard of commonly deployed non-dispersion-shifted single mode fiber with a core size of approximately 8 to 10 microns (µm).

Table 7 SONET/SDH SFP Transceiver Module Optical Transmit and Receive Specifications

SFP Transceiver Module Model	Transceiver Type	Transmit Power (dBm)	Receive Power (dBm)	Transmit and Receive Wavelength (nm)
SFP-OC3-MM	OC3-SR0, 1310 nm MMF	-14 (Max) -19 (Min)	-5 (Max) -30 (Min)	1270 to 1380
SFP-OC3-SR	OC3-SR1/STM1-I-1, 1310 nm SMF	-8 (Max) -15 (Min)	-8 (Max) -23 (Min)	1260 to 1360
SFP-OC3-IR1	OC3-IR1/STM1-S-1.1, 1310 nm SMF	-8 (Max) -15 (Min)	-8 (Max) -28 (Min)	1261 to 1360
SFP-OC3-LR1	OC3-LR1/STM1-L-1.1, 1310 nm SMF	0 (Max) -5 (Min)	-10 (Max) -34 (Min)	1263 to 1360
SFP-OC3-LR2	OC3-LR2/STM1-L-1.2, 1550 nm SMF	0 (Max) -5 (Min)	-10 (Max) -34 (Min)	1480 to 1580
SFP-OC12-MM	OC12-SR0, 1310 nm MMF	-14 (Max) -20 (Min)	-6 (Max) -26 (Min)	1270 to 1380
SFP-OC12-SR	OC12-SR1/STM4-I-4, 1310 nm SMF	-8 (Max) -15 (Min)	-8 (Max) -23 (Min)	1261 to 1360

Table 7 SONET/SDH SFP Transceiver Module Optical Transmit and Receive Specifications (continued)

SFP Transceiver Module Model	Transceiver Type	Transmit Power (dBm)	Receive Power (dBm)	Transmit and Receive Wavelength (nm)
SFP-OC12-IR1	OC12-IR1/STM4-S-4.1, 1310 nm SMF	-8 (Max) -15 (Min)	-8 (Max) -28 (Min)	1293 to 1334
SFP-OC12-LR1	OC12-LR1/STM4-L-4.1, 1310 nm SMF	+2 (Max) -3 (Min)	-8 (Max) -28 (Min)	1280 to 1335
SFP-OC12-LR2	OC12-LR2/STM4-L-4.2, 1550 nm SMF	+2 (Max) -3 (Min)	-8 (Max) -28 (Min)	1480 to 1580
SFP-OC48-SR	OC48-SR/STM16-I-16, 1310 nm SMF	-3 (Max) -10 (Min)	-3 (Max) -18 (Min)	1266 to 1360
SFP-OC48-IR1	OC48-IR1/STM16-S-16.1, 1310 nm SMF	0 (Max) -5 (Min)	0 (Max) -18 (Min)	1260 to 1360
SFP-OC48-LR2	OC48-LR2/STM16-L-16.2, 1550 nm SMF	+3 (Max) -2 (Min)	-9 (Max) -28 (Min)	1500 to 1580

Table 8 CWDM SFP Transceiver Module Optical Parameters

Parameter	Minimum	Typical	Maximum	Units	Notes and Conditions
Transmitter Center Wavelength	(x-4)	—	(x + 7)	nm	Available center wavelengths are 1470, 1490, 1510, 1530, 1550, 1570, 1590, and 1610 nm
Side-Mode Suppression Ratio	30	—		dB	
Transmitter Optical Output Power	0	—	5.0	dBm	Average power coupled into single-mode fiber
Receiver Optical Input Power (BER <10 ⁻¹² with PRBS 2-7-1)	-28.0	—	-7.0	dBm	Measured at 2.12 Gbps, 140°F (60°C) case temperature
Receiver Optical Input Power (BER <10 ⁻¹² with PRBS 2-7-1)	-29.0	—	-7.0	dBm	Measured at 1.25 Gbps, 140°F (60°C) case temperature
Receiver Optical Input Wavelength	1450	—	1620	nm	
Transmitter Extinction Ratio	9	—		dB	
Dispersion Penalty at 100 km	—	—	3	dB	Measured at 2.12 Gbps
Dispersion Penalty at 100 km	—	—	2	dB	Measured at 1.25 Gbps

Table 9 DWDM SFP Transceiver Module Optical Parameters

Parameter	Minimum	Typical	Maximum	Units	Notes and Conditions
Transmitter					
Spectral Width	—	—	0.2	nm	Full width, -20dB from maximum, with resolution bandwidth (RBW) = 0.01 nm
Transmitter Center Wavelength	x - 100	x	x + 100	pm	See Table 1 for center wavelengths
Side-Mode Suppression Ratio	30	—	—	dB	—
Transmitter Extinction Ratio	8.2	—	—	dB	—
Transmitter Optical Output Power	0	—	4.0	dBm	Average power coupled into single-mode fiber
Receiver					
Receiver Optical Input Wavelength	1530	—	1565	nm	—
Receiver Damage Threshold	—	—	+5	dBm	—
Power-Limited Performance at OSNR of 20 dB (1 GbE or 1-Gbps FC) or 21 dB (2 Gbps FC) at 0.1-nm RBW					
Optical Input Power	-28.0	—	-9.0	dBm	—
Dispersion Power Penalty < 1 GbE and 1 Gbps FC	—	—	3	dB	-800/+3600 ps/nm
Dispersion Power Penalty > 2 Gbps FC	—	—	3	dB	-800/+2400 ps/nm
Noise-Limited Performance at OSNR of 19 dB 1 GbE or 1 Gbps FC) or 20 dB (2 Gbps FC) at 0.1-nm RBW					
Optical Input Power	-22.0	—	-9.0	dB	—
Dispersion OSNR Penalty < 1 GbE and 1 Gbps FC	—	—	2	dB	-800/+3600 ps/nm
Dispersion OSNR Penalty > 2 Gbps FC	—	—	3	—	-800/+2400 ps/nm

Table 10 10-Gigabit DWDM SFP+ Transceiver Module Optical Parameters

Parameter	Symbol	Minimum	Typical	Maximum	Units	Notes and Conditions
Transmitter						
Spectral width				0.2	nm	Full width, -20 dB from maximum, with resolution bandwidth (RBW)=0.01 nm
Transmitter center wavelength		x-100	x	x+100	Pm	See Table 1 for center wavelengths
Side-mode suppression ratio	SMSR	30			dB	
Transmitter extinction ratio		9			dB	
Transmitter optical output power	P _{out}	-1.0		3.0	dBm	Average power coupled into single-mode fiber

Table 10 10-Gigabit DWDM SFP+ Transceiver Module Optical Parameters

Parameter	Symbol	Minimum	Typical	Maximum	Units	Notes and Conditions
Receiver						
Receiver optical input wavelength		1530		1565	nm	
Receiver damage threshold		4.0			dBm	
Receiver overload		-7			dBm	

Table 11 10-Gigabit DWDM SFP+ Transceiver Module Receiver Power Performance

Specification	Range	Notes and Conditions
Performance at 10G LAN and 10G WAN rates (No FEC Applications)		
Input power range	-7 to -23 dBm	At BER=1E-12, back-to-back unamplified link
Input power range (dispersion-limited)	-7 to -20 dBm	At BER=1E-12, -500 to +1600 ps/nm chromatic dispersion, unamplified link
Input power range (dispersion-limited and noise-limited)	-7 to -17 dBm	At BER=1E-12, -500 to +1600 ps/nm chromatic dispersion, amplified link with minimum 27 dB OSNR (0.1 nm RBW)
Performance at OTU/OTU2e rates (FEC Applications)		
Input power range	-7 to -27 dBm	At BER=1E-3 (pre-EFEC), back-to-back, unamplified link
Input power range (dispersion-limited)	-7 to -24 dBm	At BER=1E-3 (pre-EFEC), -500 to +1300 ps/nm chromatic dispersion, unamplified link
Input power range (dispersion-limited and noise-limited)	-7 to -17 dBm	At BER=1E-3 (pre-EFEC) -500 to +1100 ps/nm chromatic dispersion, amplified link with minimum 16 dB OSNR (0.1 nm RBW)
Input power range (dispersion-limited and noise-limited)	-7 to -17 dBm	At BER=1E-5 (pre-GFEC), -500 to +1100 ps/nm chromatic dispersion, amplified link with minimum 19 dB OSNR (0.1 nm RBW)

**Note**

Up to 1600 ps/nm chromatic dispersion is supported for fiber links between two Cisco DWDM SFP+ transceiver modules. For connections between a Cisco DWDM SFP+ transceiver module and a Cisco DWDM XENPAK, X2, or XFP transceiver module, limit the chromatic dispersion to 1300 ps/nm.

Safety

Safety warnings appear throughout this publication in procedures that may harm you if performed incorrectly or are ignored. A warning symbol precedes each warning statement.

Statement 1071—Warning Definition



Warning

IMPORTANT SAFETY INSTRUCTIONS

This warning symbol means danger. You are in a situation that could cause bodily injury. Before you work on any equipment, be aware of the hazards involved with electrical circuitry and be familiar with standard practices for preventing accidents. Use the statement number provided at the end of each warning to locate its translation in the translated safety warnings that accompanied this device.

SAVE THESE INSTRUCTIONS

Waarschuwing

BELANGRIJKE VEILIGHEIDSINSTRUCTIES

Dit waarschuwingssymbool betekent gevaar. U verkeert in een situatie die lichamelijk letsel kan veroorzaken. Voordat u aan enige apparatuur gaat werken, dient u zich bewust te zijn van de bij elektrische schakelingen betrokken risico's en dient u op de hoogte te zijn van de standaard praktijken om ongelukken te voorkomen. Gebruik het nummer van de verklaring onderaan de waarschuwing als u een vertaling van de waarschuwing die bij het apparaat wordt geleverd, wilt raadplegen.

BEWAAR DEZE INSTRUCTIES

Varoitus

TÄRKEITÄ TURVALLISUUSOHJEITA

Tämä varoitusmerkki merkitsee vaaraa. Tilanne voi aiheuttaa ruumiillisia vammoja. Ennen kuin käsittelit laitteistoa, huomioi sähköpiirien käsittelyyn liittyvät riskit ja tutustu onnettomuuksien yleisiin ehkäisytapoihin. Turvallisuusvaroitusten käännökset löytyvät laitteen mukana toimitettujen käännettyjen turvallisuusvaroitusten joukosta varoitusten lopussa näkyvien lausuntonumeroiden avulla.

SÄILYTÄ NÄMÄ OHJEET

Attention

IMPORTANTES INFORMATIONS DE SÉCURITÉ

Ce symbole d'avertissement indique un danger. Vous vous trouvez dans une situation pouvant entraîner des blessures ou des dommages corporels. Avant de travailler sur un équipement, soyez conscient des dangers liés aux circuits électriques et familiarisez-vous avec les procédures couramment utilisées pour éviter les accidents. Pour prendre connaissance des traductions des avertissements figurant dans les consignes de sécurité traduites qui accompagnent cet appareil, référez-vous au numéro de l'instruction situé à la fin de chaque avertissement.

CONSERVEZ CES INFORMATIONS

Warnung WICHTIGE SICHERHEITSHINWEISE

Dieses Warnsymbol bedeutet Gefahr. Sie befinden sich in einer Situation, die zu Verletzungen führen kann. Machen Sie sich vor der Arbeit mit Geräten mit den Gefahren elektrischer Schaltungen und den üblichen Verfahren zur Vorbeugung vor Unfällen vertraut. Suchen Sie mit der am Ende jeder Warnung angegebenen Anweisungsnummer nach der jeweiligen Übersetzung in den übersetzten Sicherheitshinweisen, die zusammen mit diesem Gerät ausgeliefert wurden.

BEWAHREN SIE DIESE HINWEISE GUT AUF.

Avvertenza IMPORTANTI ISTRUZIONI SULLA SICUREZZA

Questo simbolo di avvertenza indica un pericolo. La situazione potrebbe causare infortuni alle persone. Prima di intervenire su qualsiasi apparecchiatura, occorre essere al corrente dei pericoli relativi ai circuiti elettrici e conoscere le procedure standard per la prevenzione di incidenti. Utilizzare il numero di istruzione presente alla fine di ciascuna avvertenza per individuare le traduzioni delle avvertenze riportate in questo documento.

CONSERVARE QUESTE ISTRUZIONI

Advarsel VIKTIGE SIKKERHETSINSTRUKSJONER

Dette advarselssymbolet betyr fare. Du er i en situasjon som kan føre til skade på person. Før du begynner å arbeide med noe av utstyret, må du være oppmerksom på farene forbundet med elektriske kretser, og kjenne til standardprosedyrer for å forhindre ulykker. Bruk nummeret i slutten av hver advarsel for å finne oversettelsen i de oversatte sikkerhetsadvarslene som fulgte med denne enheten.

TA VARE PÅ DISSE INSTRUKSJONENE

Aviso INSTRUÇÕES IMPORTANTES DE SEGURANÇA

Este símbolo de aviso significa perigo. Você está em uma situação que poderá ser causadora de lesões corporais. Antes de iniciar a utilização de qualquer equipamento, tenha conhecimento dos perigos envolvidos no manuseio de circuitos elétricos e familiarize-se com as práticas habituais de prevenção de acidentes. Utilize o número da instrução fornecido ao final de cada aviso para localizar sua tradução nos avisos de segurança traduzidos que acompanham este dispositivo.

GUARDE ESTAS INSTRUÇÕES

¡Advertencia! INSTRUCCIONES IMPORTANTES DE SEGURIDAD

Este símbolo de aviso indica peligro. Existe riesgo para su integridad física. Antes de manipular cualquier equipo, considere los riesgos de la corriente eléctrica y familiarícese con los procedimientos estándar de prevención de accidentes. Al final de cada advertencia encontrará el número que le ayudará a encontrar el texto traducido en el apartado de traducciones que acompaña a este dispositivo.

GUARDE ESTAS INSTRUCCIONES

Varning! VIKTIGA SÄKERHETSANVISNINGAR

Denna varningssignal signalerar fara. Du befinner dig i en situation som kan leda till personskada. Innan du utför arbete på någon utrustning måste du vara medveten om farorna med elkretsar och känna till vanliga förfaranden för att förebygga olyckor. Använd det nummer som finns i slutet av varje varning för att hitta dess översättning i de översatta säkerhetsvarningar som medföljer denna anordning.

SPARA DESSA ANVISNINGAR**Figyelem FONTOS BIZTONSÁGI ELOÍRÁSOK**

Ez a figyelmeztető jel veszélyre utal. Sérülésveszélyt rejtő helyzetben van. Mielőtt bármely berendezésen munkát végezte, legyen figyelemmel az elektromos áramkörök okozta kockázatokra, és ismerkedjen meg a szokásos balesetvédelmi eljárásokkal. A kiadványban szereplő figyelmeztetések fordítása a készülékhez mellékelt biztonsági figyelmeztetések között található; a fordítás az egyes figyelmeztetések végén látható szám alapján kereshető meg.

ORIZZE MEG EZEKET AZ UTASÍTÁSOKAT!**Предупреждение ВАЖНЫЕ ИНСТРУКЦИИ ПО СОБЛЮДЕНИЮ ТЕХНИКИ БЕЗОПАСНОСТИ**

Этот символ предупреждения обозначает опасность. То есть имеет место ситуация, в которой следует опасаться телесных повреждений. Перед эксплуатацией оборудования выясните, каким опасностям может подвергаться пользователь при использовании электрических цепей, и ознакомьтесь с правилами техники безопасности для предотвращения возможных несчастных случаев. Воспользуйтесь номером заявления, приведенным в конце каждого предупреждения, чтобы найти его переведенный вариант в переводе предупреждений по безопасности, прилагаемом к данному устройству.

СОХРАНИТЕ ЭТИ ИНСТРУКЦИИ**警告 重要的安全性说明**

此警告符号代表危险。您正处于可能受到严重伤害的工作环境中。在您使用设备开始工作之前，必须充分意识到触电的危险，并熟练掌握防止事故发生的标准工作程序。请根据每项警告结尾提供的声明号码来找到此设备的安全性警告说明的翻译文本。

请保存这些安全性说明

警告 安全上の重要な注意事項

「危険」の意味です。人身事故を予防するための注意事項が記述されています。装置の取り扱い作業を行うときは、電気回路の危険性に注意し、一般的な事故防止策に留意してください。警告の各国語版は、各注意事項の番号を基に、装置に付属の「Translated Safety Warnings」を参照してください。

これらの注意事項を保管しておいてください。

주의 **중요 안전 지침**

이 경고 기호는 위험을 나타냅니다. 작업자가 신체 부상을 일으킬 수 있는 위험한 환경에 있습니다. 장비에 작업을 수행하기 전에 전기 회로와 관련된 위험을 숙지하고 표준 작업 관례를 숙지하여 사고를 방지하십시오. 각 경고의 마지막 부분에 있는 경고문 번호를 참조하여 이 장치와 함께 제공되는 번역된 안전 경고문에서 해당 번역문을 찾으십시오.

이 지시 사항을 보관하십시오.

Aviso **INSTRUÇÕES IMPORTANTES DE SEGURANÇA**

Este símbolo de aviso significa perigo. Você se encontra em uma situação em que há risco de lesões corporais. Antes de trabalhar com qualquer equipamento, esteja ciente dos riscos que envolvem os circuitos elétricos e familiarize-se com as práticas padrão de prevenção de acidentes. Use o número da declaração fornecido ao final de cada aviso para localizar sua tradução nos avisos de segurança traduzidos que acompanham o dispositivo.

GUARDE ESTAS INSTRUÇÕES**Advarsel** **VIGTIGE SIKKERHEDSANVISNINGER**

Dette advarselssymbol betyder fare. Du befinder dig i en situation med risiko for legemeskadedigelse. Før du begynder arbejde på udstyr, skal du være opmærksom på de involverede risici, der er ved elektriske kredsløb, og du skal sætte dig ind i standardprocedurer til undgåelse af ulykker. Brug erklæringsnummeret efter hver advarsel for at finde oversættelsen i de oversatte advarsler, der fulgte med denne enhed.

GEM DISSE ANVISNINGER**تحذير****إرشادات الأمان الهامة**

يوضح رمز التحذير هذا وجود خطر. وهذا يعني أنك متواجد في مكان قد ينتج عنه التعرض لإصابات. قبل بدء العمل، احذر مخاطر التعرض للصدمة الكهربائية وكن على علم بالإجراءات القياسية للحيلولة دون وقوع أي حوادث. استخدم رقم البيان الموجود في آخر كل تحذير لتحديد مكان ترجمته داخل تحذيرات الأمان المترجمة التي تأتي مع الجهاز. قم بحفظ هذه الإرشادات

Upozorenje **VAŽNE SIGURNOSNE NAPOMENE**

Ovaj simbol upozorenja predstavlja opasnost. Nalazite se u situaciji koja može prouzročiti tjelesne ozljede. Prije rada s bilo kojim uređajem, morate razumjeti opasnosti vezane uz električne sklopove, te biti upoznati sa standardnim načinima izbjegavanja nesreća. U prevedenim sigurnosnim upozorenjima, priloženima uz uređaj, možete prema broju koji se nalazi uz pojedino upozorenje pronaći i njegov prijevod.

SAČUVAJTE OVE UPUTE

Upozornění DŮLEŽITÉ BEZPEČNOSTNÍ POKYNY

Tento upozorňující symbol označuje nebezpečí. Jste v situaci, která by mohla způsobit nebezpečí úrazu. Před prací na jakémkoliv vybavení si uvědomte nebezpečí související s elektrickými obvody a seznamte se se standardními opatřeními pro předcházení úrazům. Podle čísla na konci každého upozornění vyhledejte jeho překlad v přeložených bezpečnostních upozorněních, která jsou přiložena k zařízení.

USCHOVEJTE TYTO POKYNY**Προειδοποίηση ΣΗΜΑΝΤΙΚΕΣ ΟΔΗΓΙΕΣ ΑΣΦΑΛΕΙΑΣ**

Αυτό το προειδοποιητικό σύμβολο σημαίνει κίνδυνο. Βρίσκεστε σε κατάσταση που μπορεί να προκαλέσει τραυματισμό. Πριν εργαστείτε σε οποιοδήποτε εξοπλισμό, να έχετε υπόψη σας τους κινδύνους που σχετίζονται με τα ηλεκτρικά κυκλώματα και να έχετε εξοικειωθεί με τις συνήθεις πρακτικές για την αποφυγή ατυχημάτων. Χρησιμοποιήστε τον αριθμό δήλωσης που παρέχεται στο τέλος κάθε προειδοποίησης, για να εντοπίσετε τη μετάφρασή της στις μεταφρασμένες προειδοποιήσεις ασφαλείας που συνοδεύουν τη συσκευή.

ΦΥΛΑΞΤΕ ΑΥΤΕΣ ΤΙΣ ΟΔΗΓΙΕΣ**אזהרה****הוראות בטיחות חשובות**

סימן אזהרה זה מסמל סכנה. אתה נמצא במצב העלול לגרום לפציעה. לפני שתעבוד עם ציוד כלשהו, עליך להיות מודע לסכנות הכרוכות במגעלים חשמליים ולהכיר את הנהלים המקובלים למניעת תאונות. השתמש במספר ההוראה המסופק בסופה של כל אזהרה כדי לאתר את התרגום באזהרות הבטיחות המתורגמות שמצורפות להתקן.

שמור הוראות אלה**Opomena ВАЖНИ БЕЗБЕДНОСНИ НАПАТСТВИЈА**

Симболот за предупредување значи опасност. Се наоѓате во ситуација што може да предизвика телесни повреди. Пред да работите со опремата, бидете свесни за ризикот што постои кај електричните кола и треба да ги познавате стандардните постапки за спречување на несреќни случаи. Искористете го бројот на изјавата што се наоѓа на крајот на секое предупредување за да го најдете неговиот период во преведените безбедносни предупредувања што се испорачани со уредот.

ЧУВАЈТЕ ГИ ОБИЕ НАПАТСТВИЈА

Ostrzeżenie WAŻNE INSTRUKCJE DOTYCZĄCE BEZPIECZEŃSTWA

Ten symbol ostrzeżenia oznacza niebezpieczeństwo. Zachodzi sytuacja, która może powodować obrażenia ciała. Przed przystąpieniem do prac przy urządzeniach należy zapoznać się z zagrożeniami związanymi z układami elektrycznymi oraz ze standardowymi środkami zapobiegania wypadkom. Na końcu każdego ostrzeżenia podano numer, na podstawie którego można odszukać tłumaczenie tego ostrzeżenia w dołączonym do urządzenia dokumencie z tłumaczeniami ostrzeżeń.

NINIEJSZE INSTRUKCJE NALEŻY ZACHOWAĆ**Upozornenie DÔLEŽITÉ BEZPEČNOSTNÉ POKYNY**

Tento varovný symbol označuje nebezpečenstvo. Nachádzate sa v situácii s nebezpečenstvom úrazu. Pred prácou na akomkoľvek vybavení si uvedomte nebezpečenstvo súvisiace s elektrickými obvodmi a oboznámte sa so štandardnými opatreniami na predchádzanie úrazom. Podľa čísla na konci každého upozornenia vyhľadajte jeho preklad v preložených bezpečnostných upozorneniach, ktoré sú priložené k zariadeniu.

USCHOVAJTE SI TENTO NÁVOD**Warning****Class 1 laser product.** Statement 1008**Warning****Laser radiation is present when the system is open and interlocks bypassed.** Statement 1014**Warning****Only trained and qualified personnel should be allowed to install, replace, or service this equipment.** Statement 1030

Required Tools

You will need these tools to install the SFP transceiver module:

- Wrist strap or other personal grounding device to prevent ESD occurrences.
- Antistatic mat or antistatic foam to set the transceiver on.
- Fiber-optic end-face cleaning tools and inspection equipment. For complete information on inspecting and cleaning fiber-optic connections, see the white-paper document at this URL:

http://www.cisco.com/en/US/tech/tk482/tk876/technologies_white_paper09186a0080254eba.shtml

Installing SFP and SFP+ Transceiver Modules

SFP transceiver modules can have three types of latching devices to secure an SFP transceiver module in a port socket:

- [Figure 4](#) shows an SFP transceiver module with a Mylar tab latch.
- [Figure 5](#) shows an SFP transceiver module with an actuator button latch.
- [Figure 6](#) shows an SFP transceiver module that has a bail clasp latch.
- [Figure 7](#) shows an SFP+ transceiver module that has a bail clasp latch.

Determine which type of latch your SFP transceiver module uses before following the installation and removal procedures.



Caution

Do not install or remove the SFP transceiver module with fiber-optic cables still attached to it. Doing so may damage cables, cable connectors, or the optical interfaces and may interfere with the SFP transceiver module latching properly into its socket connector. Disconnect all cables before removing or installing an SFP transceiver module.

Removing and installing an SFP transceiver module can shorten its useful life. Do not remove and insert SFP transceiver modules more often than is absolutely necessary.



Caution

The SFP transceiver modules are static sensitive devices. Always use an ESD wrist strap or similar individual grounding device when handling SFP transceiver modules or coming in contact with modules.

Figure 4 *SFP Transceiver Module with a Mylar Tab Latch*

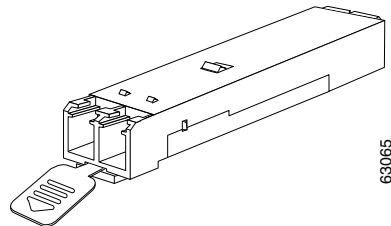

Figure 5 *SFP Transceiver Module with an Actuator Button Latch*

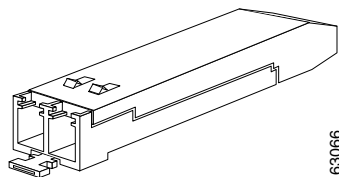

Figure 6 SFP Module with a Bail Clasp Latch

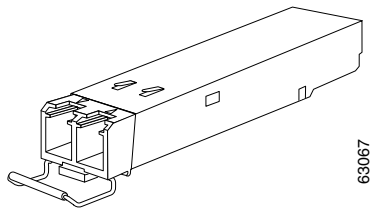
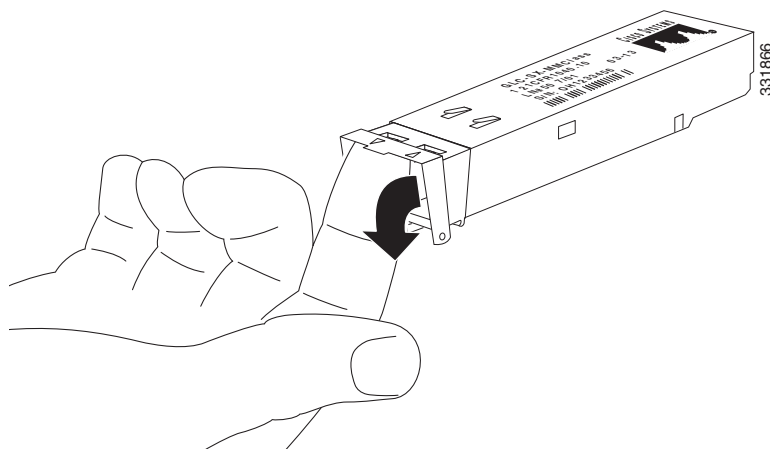

Figure 7 SFP+ Module with a Bail Clasp Latch



To install an SFP transceiver module, follow these steps:

-
- Step 1** Attach an ESD-preventive wrist strap to your wrist and to the ESD ground connector or a bare metal surface on your chassis.
 - Step 2** Remove the SFP transceiver module from its protective packaging.
-
- Note** Do not remove the optical bore dust plugs until directed to do so later in the procedure.
-
- Step 3** Check the label on the SFP transceiver module body to verify that you have the correct model for your network.
 - Step 4** Find the send (TX) and receive (RX) markings that identify the top side of the SFP transceiver module.
-
- Note** On some SFP transceiver modules, the TX and RX marking might be replaced by arrowheads pointing from the SFP transceiver module connector (transmit direction or TX) and toward the connector (receive direction or RX).
-
- Step 5** Position the SFP transceiver module in front of the socket opening.

**Note**

Different Cisco devices have different SFP module socket configurations. Your Cisco device could have either a latch-up or a latch-down orientation. Ensure that you are installing the SFP transceiver module in the correct orientation for your Cisco device. For more details, see the hardware installation instructions that came with your Cisco device.

- Step 6** Holding it as shown in [Figure 8](#), insert the SFP into the socket until you feel the connector latch into place.

Figure 8 *Inserting an SFP Transceiver Module into a Module Socket*

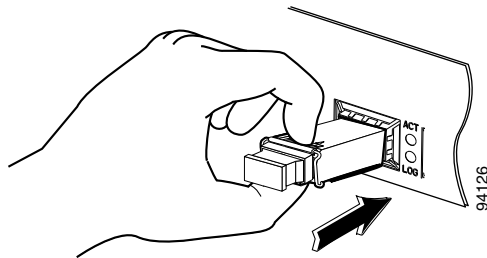

Step 7 Press the SFP into the slot firmly with your thumb as shown in [Figure 9](#).



Note For SFP transceiver modules equipped with an actuator latch, you must press firmly on both the transceiver faceplate and the actuator button to ensure that the transceiver is properly latched in the socket.

Figure 9 Latching the SFP

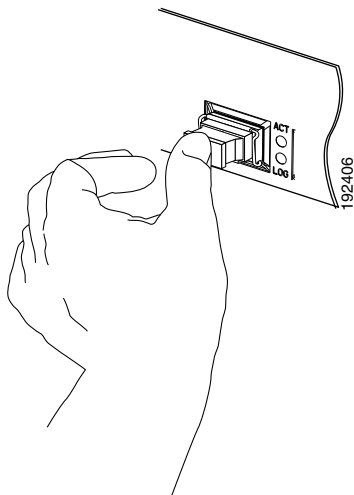

Step 8 To verify that the SFP is seated and latched properly:

- a. Grasp the SFP as shown in [Figure 10](#) and try to remove it without releasing the latch.
- b. If the SFP can not be removed, it is installed and seated properly. If the SFP can be removed, reinsert it and press harder with your thumb, repeating if necessary until it is latched securely into the socket.

Figure 10 Verifying SFP Installation

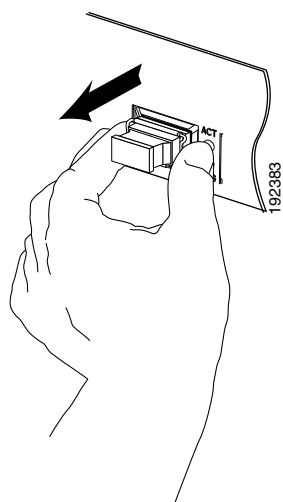

**Note**

For optical SFP transceiver modules, before removing the dust plugs and making any optical connections, observe the following guidelines:

- Always keep the protective dust plugs on the unplugged fiber-optic cable connectors and the transceiver optical bores until you are ready to make a connection.
- Always inspect and clean the LC connector end-faces just before making any connections. See the Tip on this page for a pointer to a fiber-optic inspection and cleaning white paper.
- Always grasp the LC connector housing to plug or unplug a fiber-optic cable.

Step 9 Remove the dust plugs from the network interface cable LC connectors. Save the dust plugs for future use.

Step 10 Inspect and clean the LC connector's fiber-optic end-faces. See the following Tip for a pointer to a fiber-optic inspection and cleaning white paper.

**Tip**

For complete information on inspecting and cleaning fiber-optic connections, see the white-paper document at this URL:

http://www.cisco.com/en/US/tech/tk482/tk876/technologies_white_paper09186a0080254eba.shtml

Step 11 Remove the dust plugs from the SFP transceiver module optical bores.

Step 12 Immediately attach the network interface cable LC connector to the SFP transceiver module.

Step 13 To connect 1000BASE-T SFP transceiver modules to a copper network, follow these substeps:

**Caution**

To comply with GR-1089 intrabuilding lightning immunity requirements, you must use grounded, shielded, twisted-pair Category 5 cabling.

- Insert the Category 5 network cable RJ-45 connector into the SFP transceiver module RJ-45 connector.

**Note**

When connecting to a 1000BASE-T-compatible server, workstation, or router, use four twisted-pair, straight-through Category 5 cabling for the SFP transceiver module port. When connecting to a 1000BASE-T-compatible switch or repeater, use four twisted-pair, crossover Category 5 cabling.

- Insert the other end of the network cable into an RJ-45 connector on a 1000BASE-T-compatible target device.

Step 14 Observe the port status LED:

- The LED turns green when the SFP transceiver module and the target device have an established link.
- The LED turns amber while the STP feature discovers the network topology and searches for loops. This process takes about 30 seconds, and then the LED turns green.
- If the LED is off, the target device might not be turned on, there might be a cable problem, or there might be a problem with the adapter installed in the target device. See the Troubleshooting section of your switch hardware guide for solutions to cabling problems.

Step 15 Reconfigure and reboot the target device if necessary.

Removing SFP and SFP+ Transceiver Modules



Caution

The SFP and SFP+ transceiver modules are static sensitive devices. Always use an ESD wrist strap or similar individual grounding device when handling the transceiver modules or coming in contact with modules.



Caution

Be careful when removing GLC-GE-100FX SFPs from a WS-C3750G-12S-S switch. The SFP transceiver module temperature might go over 160°F (70°C) and be too hot to touch with bare hands.

If you are removing an SFP or SFP+ transceiver module, follow these steps:

Step 1 Attach an ESD-preventive wrist strap to your wrist and to the ESD ground connector or a bare metal surface on your chassis.

Step 2 Disconnect the network fiber-optic cable or network copper cable from the transceiver module connector. For optical transceiver modules, immediately reinstall the dust plugs in the transceiver module's optical bores and the fiber-optic cable LC connectors.



Tip

For reattachment of fiber-optic cables, note which connector plug is send (TX) and which is receive (RX).

Step 3 Release and remove the transceiver module from the socket connector, as shown in [Figure 11](#), [Figure 12](#), [Figure 13](#), or

- If the SFP transceiver module has a Mylar tab latch, pull the tab gently in a slightly downward direction until the transceiver disengages from the socket connector, and then pull the SFP transceiver module straight out. Do not twist or pull the Mylar tab because you could detach it from the SFP transceiver module.

Figure 11 *Removing an SFP Transceiver Module Equipped with a Mylar Tab*

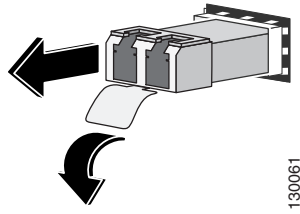

- If the SFP transceiver module has an actuator button latch, gently press the actuator button on the front of the SFP transceiver module until it clicks and the latch mechanism releases the SFP transceiver module from the socket connector. Grasp the actuator button between your thumb and index finger, and carefully pull the SFP transceiver module straight from the module slot.

Figure 12 *Removing an SFP Transceiver Module Equipped with an Actuator Button Latch*

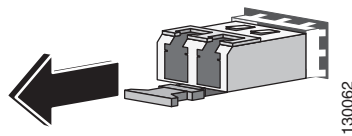

- If the SFP transceiver module has a bail clasp latch, pull the latch out and down to eject the SFP transceiver module from the socket connector. If the bail clasp latch is obstructed and you cannot use your index finger to open it, use a small, flat-blade screwdriver or other long, narrow instrument to open the bail clasp latch. Grasp the SFP transceiver module between your thumb and index finger, and carefully remove it from the socket.

Figure 13 *Removing an SFP Transceiver Module Equipped with a Bail Clasp Latch*

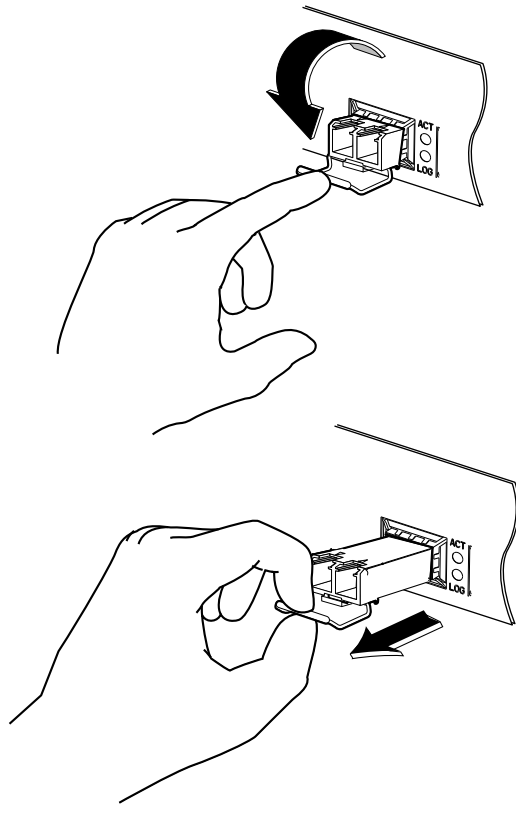

94127

- The SFP+ transceiver uses a bail clasp style latch which is slightly different than the bail clasp latch for the SFP transceiver. The SFP+ transceiver bail clasp has a small tab protruding down from the bail clasp handle. To release the SFP+ bail clasp, push the small tab up and outwards with your index finger to release the bail clasp. Grasp the SFP+ transceiver between your thumb and index finger and carefully remove the transceiver from the socket.

Figure 14 Removing an SFP+ Transceiver Equipped with a Bail Clasp Latch with Tab

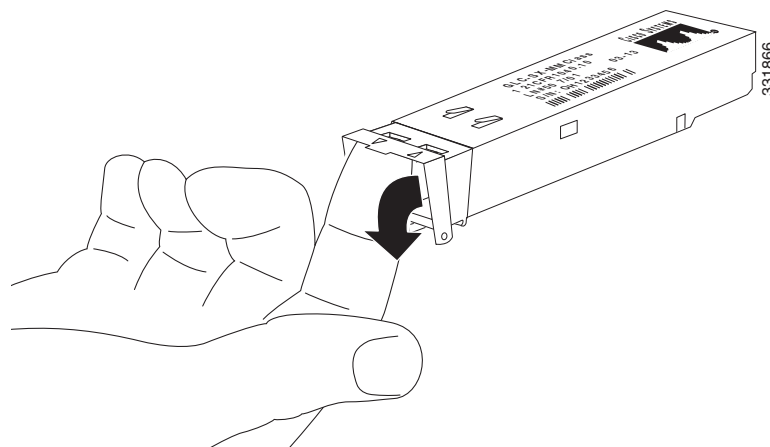

Step 4 Place the removed transceiver module in an antistatic bag or other protective environment.

Standards and Compliance Specifications for SFP and SFP+ Optical Transceivers

This section provides compliance information for the SFP and SFP+ optical transceivers.

FCC Class A Compliance

This equipment has been tested and found to comply with the limits for a Class A digital device, pursuant to part 15 of the FCC rules. These limits are designed to provide reasonable protection against harmful interference when the equipment is operated in a commercial environment. This equipment generates, uses, and can radiate radio-frequency energy and, if not installed and used in accordance with the instruction manual, may cause harmful interference to radio communications. Operation of this equipment in a residential area is likely to cause harmful interference, in which case users will be required to correct the interference at their own expense.

You can determine whether your equipment is causing interference by turning it off. If the interference stops, it was probably caused by the Cisco equipment or one of its peripheral devices. If the equipment causes interference to radio or television reception, try to correct the interference by using one or more of the following measures:

- Turn the television or radio antenna until the interference stops.
- Move the equipment to one side or the other of the television or radio.
- Move the equipment farther away from the television or radio.
- Plug the equipment into an outlet that is on a different circuit from the television or radio. (That is, make certain the equipment and the television or radio are on circuits controlled by different circuit breakers or fuses.)

Modifications to this product not authorized by Cisco Systems could void the FCC approval and negate your authority to operate the product.

Class 1 Laser Compliance

This product has been tested and found to comply with the limits for Class 1 laser for IEC60825, EN60825, and 21CFR1040 specifications.

Translated Safety Warnings

This section repeats in multiple languages the basic warnings that appear in this document.

Statement 1008—Class 1 Laser Product



Warning

Class 1 laser product.

Waarschuwing

Klasse-1 laser produkt.

Varoitus

Luokan 1 lasertuote.

Attention

Produit laser de classe 1.

Warnung

Laserprodukt der Klasse 1.

Avvertenza

Prodotto laser di Classe 1.

Advarsel

Laserprodukt av klasse 1.

Aviso

Producto laser de classe 1.

¡Advertencia!

Producto láser Clase I.

Varning!

Laserprodukt av klass 1.

Figyelem

Class 1 besorolású lézeres termék.

Предупреждение

Лазерное устройство класса 1.

警告

这是 1 类激光产品。

警告

クラス1レーザー製品です。

주의	클래스 1 레이저 제품.
Aviso	Produto a laser de classe 1.
Advarsel	Klasse 1 laserprodukt.
تحذير	Class 1 Laser منتج ١
Upozorenje	Laserski proizvod klase 1
Upozornění	Laserový výrobek třídy 1.
Προειδοποίηση	Προϊόν λέιζερ κατηγορίας 1.
אזהרה	מוצר לייזר Class 1.
Opomena	Ласерски производ од класа 1.
Ostrzeżenie	Produkt laserowy klasy 1.
Upozornenie	Laserový výrobok triedy 1.
Opozorilo	Laserski izdelek 1. razreda.

Statement 1014—Laser Radiation



Warning

Laser radiation is present when the system is open and interlocks bypassed.

Waarschuwing

Laserstraling is aanwezig wanneer het systeem open is en onderlinge vergrendelingen ongedaan zijn gemaakt.

Varoitus

Lasersäteitä järjestelmän ollessa avoinna ja suojalukituksen ohitettuna.

Attention

Production d'un rayonnement laser en position ouverte avec les verrouillages désactivés.

Warnung

Laserstrahlung in geöffnetem Zustand oder bei deaktivierter Verriegelung.

Avvertenza

Emissione di radiazioni laser quando il sistema è aperto e i dispositivi di blocco sono disattivati.

Advarsel	Laserstråling er til stede når enheten er åpen og låsemekanismene er omgått.
Aviso	Radiação presente quando o sistema estiver aberto e os bloqueios estiverem desviados.
¡Advertencia!	Radiación láser presente si el sistema está abierto y con los enclavamientos desirados.
Varning!	Laserstrålning pågår när enheten är öppen och förregleringen är förbikopplad.
Figyelem	A rendszer burkolatának eltávolítása és a védőkapcsolók kiiktatása esetén lézersugárzás van jelen.
Предупреждение	Открытое устройство с неподключенными соединителями испускает лазерное излучение.
警告	打开系统和互锁旁路都会发生激光辐射。
警告	システムを開きインターロックを外した状態では、レーザーが放射されています。

Statement 1030—Equipment Installation



Warning	Only trained and qualified personnel should be allowed to install, replace, or service this equipment.
Waarschuwing	Deze apparatuur mag alleen worden geïnstalleerd, vervangen of hersteld door bevoegd geschoold personeel.
Varoitus	Tämän laitteen saa asentaa, vaihtaa tai huoltaa ainoastaan koulutettu ja laitteen tunteva henkilökunta.
Attention	Il est vivement recommandé de confier l'installation, le remplacement et la maintenance de ces équipements à des personnels qualifiés et expérimentés.
Warnung	Das Installieren, Ersetzen oder Bedienen dieser Ausrüstung sollte nur geschultem, qualifiziertem Personal gestattet werden.
Avvertenza	Questo apparato può essere installato, sostituito o mantenuto unicamente da un personale competente.
Advarsel	Bare opplært og kvalifisert personell skal foreta installasjoner, utskiftninger eller service på dette utstyret.
Aviso	Apenas pessoal treinado e qualificado deve ser autorizado a instalar, substituir ou fazer a revisão deste equipamento.

¡Advertencia!	Solamente el personal calificado debe instalar, reemplazar o utilizar este equipo.
Varning!	Endast utbildad och kvalificerad personal bör få tillåtelse att installera, byta ut eller reparera denna utrustning.
Figyelem	A berendezést csak szakképzett személyek helyezhetik üzembe, cserélhetik és tarthatják karban.
Предупреждение	Установку, замену и обслуживание этого оборудования может осуществлять только специально обученный квалифицированный персонал.
警告	只有经过培训且具有资格的人员才能进行此设备的安装、更换和维修。
警告	この装置の設置、交換、保守は、訓練を受けた相応の資格のある人が行ってください。
주의	교육을 받고 자격을 갖춘 사람만 이 장비를 설치, 교체, 또는 서비스를 수행해야 합니다.
Aviso	Somente uma equipe treinada e qualificada tem permissão para instalar, substituir ou dar manutenção a este equipamento.
Advarsel	Kun uddannede personer må installere, udskifte komponenter i eller servicere dette udstyr.
تحذير	يسمح للمنيين المتخصصين فقط بتركيب المعدة أو استبدالها أو إجراء الصيانة عليها.
Upozorenje	Uređaj smije ugrađivati, mijenjati i servisirati samo za to obučeno i osposobljeno servisno osoblje.
Upozornění	Instalaci, výměnu nebo opravu tohoto zařízení směji provádět pouze proškolené a kvalifikované osoby.
Προειδοποίηση	Η τοποθέτηση, η αντικατάσταση και η συντήρηση του εξοπλισμού επιτρέπεται να γίνονται μόνο από καταρτισμένο προσωπικό με τα κατάλληλα προσόντα.
אזהרה	רק עובדים מיומנים ומוסמכים רשאים להתקין, להחליף, או לטפל בצידוד זה.
	Местењето, заменувањето и сервисирањето на оваа опрема треба да му биде дозволено само на обучен и квалификуван персонал.
Ostrzeżenie	Do instalacji, wymiany i serwisowania tych urządzeń mogą być dopuszczone wyłącznie osoby wykwalifikowane i przeszkolone.
Upozornenie	Inštaláciu, výmenu alebo opravu tohto zariadenia smú vykonávať iba vyškolené a kvalifikované osoby.

Opozorilo Opremo lahko priključi, zamenja ali popravi le za to usposobljeno osebje.

警告 唯有經訓練的合格人員才能安裝、替換或維修該設備。

Obtaining Documentation and Submitting a Service Request

For information on obtaining documentation, submitting a service request, and gathering additional information, see the monthly *What's New in Cisco Product Documentation*, which also lists all new and revised Cisco technical documentation, at:

<http://www.cisco.com/en/US/docs/general/whatsnew/whatsnew.html>

Subscribe to the *What's New in Cisco Product Documentation* as a Really Simple Syndication (RSS) feed and set content to be delivered directly to your desktop using a reader application. The RSS feeds are a free service and Cisco currently supports RSS version 2.0.

Cisco and the Cisco logo are trademarks or registered trademarks of Cisco and/or its affiliates in the U.S. and other countries. To view a list of Cisco trademarks, go to this URL: www.cisco.com/go/trademarks. Third-party trademarks mentioned are the property of their respective owners. The use of the word partner does not imply a partnership relationship between Cisco and any other company. (1110R)

Copyright © 2003–2012, Cisco Systems, Inc. All rights reserved.