

AXIS Q1602/-E Network Cameras

Outstanding image performance in poor light conditions.



- > Outstanding light sensitivity with Lightfinder technology
- > Extended D1 resolution
- > Multiple H.264 video stream
- > Power over Ethernet
- > Outdoor-ready model with Arctic Temperature Control

The indoor AXIS Q1602 and the outdoor-ready model, AXIS Q1602-E, are designed for video surveillance in poor light conditions, where users require color information in the video to enhance recognition and identification of objects.

The unique Lightfinder technology developed by Axis makes AXIS Q1602/-E cameras extremely sensitive to low light, effectively allowing the cameras to 'see' even in dark conditions. The camera can maintain focus during daylight and infrared light and heralds a new generation of surveillance cameras with outstanding performance.

The fixed AXIS Q1602/-E cameras deliver progressive scan image quality at extended D1 (768x576) resolution, multiple, individually configurable H.264 and Motion JPEG video streams simultaneously.

Installation is made easy with Power over Ethernet (PoE, IEEE 802.3af), which eliminates the need for power cables. The cameras also have an SD/SDHC memory card slot for storing recordings locally.

The IP66-rated outdoor-ready model, AXIS Q1602-E camera, operates in temperatures from -40 °C to 50 °C (-40 °F to 122 °F) using PoE and High PoE, and features Axis' unique Arctic Temperature Control to pre-heat the camera module for securing start up even at very low temperatures following a power failure.



Low-light sensitive cameras for indoor and outdoor use

AXIS Q1602/-E Network Cameras offer fixed network cameras suitable for environments with poor light conditions. Incorporating Axis' revolutionary Lightfinder technology, the cameras can maintain focus during daylight and infrared light and heralds a new generation of surveillance cameras with outstanding performance.

Easy installation with focus assistant, remote back focus and pixel counter

Setting the focus on AXIS Q1602/-E cameras is made easy with the focus assistant, which indicates with a flashing green LED when an image is in focus after manually adjusting the lens. Additionally, they offer remote back focus, which allows the focus to be fine-tuned from a computer. The pixel counter further helps the installer verify that the pixel resolution of an object fulfills regulatory or customer requirements, for example, for facial identification.

Lightfinder technology

AXIS Q1602/-E incorporate a new and revolutionary technology by Axis, called Lightfinder. The Lightfinder technology incorporates a CMOS sensor with exceptional light sensitivity. However, this technology is much more than just the sensor. As per Axis' proven image processing, already used in all its network video products, the elaborate software sets the degree of filtering and sharpening to give the best image quality possible. The outstanding performance in low light is the result of well-founded decisions regarding the sensor and lens combined with carefully tuned image processing.

Compared to any analog or network camera, the Lightfinder technology will give more life-like colors, in low-light conditions. The noise reduction of the Lightfinder technology is vastly improved compared to any surveillance camera on the market, which in combination with the light sensitivity of the sensor gives a superior image quality. For more on Lightfinder technology, go to: www.axis.com/corporate/corp/tech_papers.htm

Outdoor-ready

AXIS Q1602-E Network Camera save installation time and costs since it is ready out of the box for mounting outdoors. The IP66-rated camera has protection against dust, rain, snow and sunlight, and can operate in temperatures as low as -40 °C (-40 °F). The camera is powered by Power over Ethernet, which makes installation easy since there is no need for a separate power cable. An integrated dehumidifying membrane eliminates any humidity caught in the camera enclosure during installation. The camera enables easy mounting of an infrared illuminator under the enclosure. It comes with a wall mount bracket and a sunshield.



Lightfinder technology with AXIS Q1602/-E Network Cameras



Reference image



High-end surveillance camera

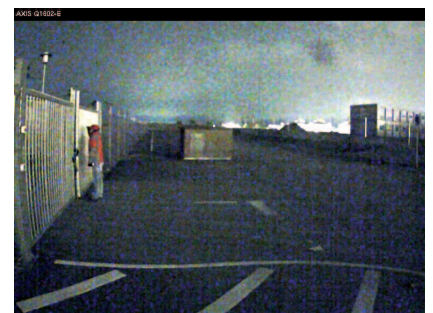

AXIS Q1602/-E Network Cameras

Technical Specifications – AXIS Q1602/-E Network Cameras

Camera	
Models	AXIS Q1602: Extended D1 (768x576) resolution, indoor AXIS Q1602-E: Extended D1 (768x576) resolution, outdoor
Image sensor	Progressive scan RGB CMOS 1/3"
Lens	Varifocal 2.8 – 8 mm, IR corrected, CS-mount Horizontal angle of view: 89° – 34° view, F1.2, DC-iris Support for P-Iris lens
Day and night	Automatically removable infrared-cut filter
Minimum illumination	Color: 0.05 lux, F1.2, B/W: 0.008 lux, F1.2
Shutter time	1/59000 s to 2 s
Video	
Video compression	H.264 (MPEG-4 Part 10/AVC) H.264 Baseline and Main Profile Motion JPEG
Resolutions	768x576 to 160x90
Frame rate H.264	30 fps in all resolutions
Frame rate Motion JPEG	30 fps in all resolutions
Video streaming	Multiple, individually configurable streams in H.264/Motion JPEG Controllable frame rate and bandwidth VBR/CBR H.264
Image settings	Compression, color, brightness, sharpness, contrast, white balance, exposure control, exposure zones, backlight compensation, fine tuning of behavior at low light, wide dynamic range – dynamic contrast AXIS Q1602: Rotation: 0°, 90°, 180°, 270° and Corridor Format™ Text and image overlay, privacy mask and mirroring of images
Audio	
Audio streaming	Two-way
Audio compression	AAC LC 8/16 kHz G.711 PCM 8 kHz G.726 ADPCM 8 kHz Configurable bit rate
Audio input/output	External microphone input or line input, line output AXIS Q1602: Built-in microphone
Network	
Security	Password protection, IP address filtering, HTTPS encryption**, IEEE 802.1X network access control**, digest authentication, user access log
Supported protocols	IPv4/v6, HTTP, HTTPS**, QoS Layer 3 DiffServ, FTP, SMTP, Bonjour, UPnP, SNMPv1/v2c/v3(MIB-II), DNS, DynDNS, NTP, RTSP, RTP, TCP, UDP, IGMP, RTCP, ICMP, DHCP, ARP, SOCKS

System integration	
Application Programming Interface	Open API for software integration, including the ONVIF specification available at www.onvif.org , as well as VAPIX® and AXIS Camera Application Platform from Axis Communications, specifications available at www.axis.com Support for AXIS Video Hosting System (AVHS) with One-Click Camera connection
Intelligent video	Video motion detection, active tampering alarm, audio detection Support for AXIS Camera Application Platform enabling installation of additional applications
Events	Intelligent video, external input
Alarm actions	File upload via FTP, HTTP and email Notification via email, HTTP and TCP External output activation Video and audio recording to edge storage Pre- and post-alarm video buffering
Installation aids in software	Focus assistant, remote back focus, pixel counter
General	
Casing	Camera: Metal (zinc) AXIS Q1602-E: IP66- and NEMA 4X-rated, IK10 impact resistant aluminum enclosure Color: white NCS S 1002-B
Processor and memory	ARTPEC-4, 256 MB RAM, 128 MB Flash
Power	Power over Ethernet (PoE) IEEE 802.3af AXIS Q1602: max. 6.8 W, PoE Class 3 AXIS Q1602-E: PoE IEEE 802.3af max. 12.95 W or High PoE max 25.5 W
Connectors	RJ-45 10BASE-T/100BASE-TX PoE Terminal block for 1 alarm input and 1 output 3.5 mm mic/line in, 3.5 mm line out
Edge storage	SD/SDHC memory card slot (card not included) Support for recording to network share (Network Attached Storage or file server)
Operating conditions	AXIS Q1602: 0 °C to 50 °C (32 °F to 122 °F); Humidity 20 – 80% RH (non-condensing) AXIS Q1602-E: -30 °C to 50 °C (-22 °F to 122 °F) with PoE; down to -40 °C (-40 °F) with High PoE
Approvals	EN 55022 Class B, EN 61000-3-2, EN 61000-3-3, EN 61000-6-1, EN 61000-6-2, EN 55024, FCC Part 15 Subpart B Class B, ICES-003 Class B, VCCI Class B, C-tick AS/NZS CISPR 22, KC, EN 60950-1, IEC60950-1 AXIS Q1602-E: IEC 60529 IP66, NEMA 250 Type 4X, IEC 62262 IK10, IEC60950-22
Weight	AXIS Q1602: 0.6 kg (1.3 lb.) AXIS Q1602-E: 3.1 kg (6.8 lb.)
Included accessories	Stand, connector kit, Installation Guide, CD with installation tools, recording software and User's Manual, Windows decoder 1-user license AXIS Q1602-E: Wall mount bracket, sunshield

** This product includes software developed by the OpenSSL Project for use in the OpenSSL Toolkit. (www.openssl.org)

More information is available at www.axis.com

Dimensions: AXIS Q1602 Network Camera

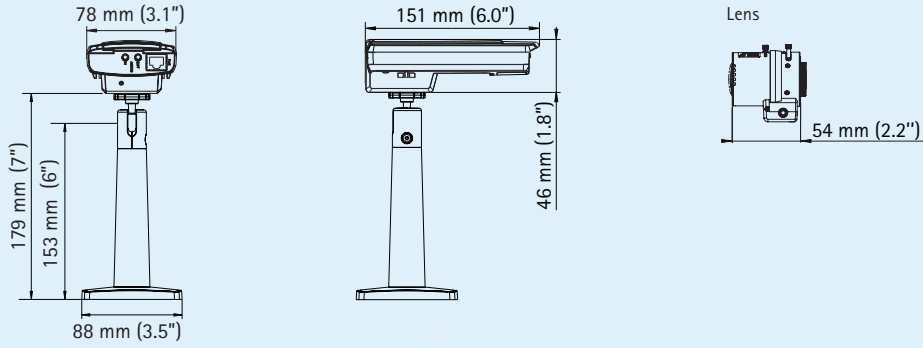

Dimensions: AXIS Q1602-E Network Camera and wall bracket with internal cable channel

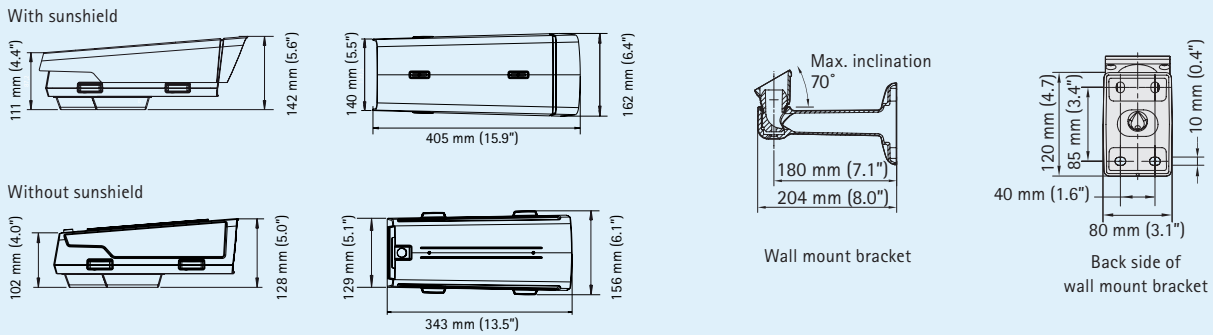

Optional accessories

AXIS PoE Midspan 1-port



AXIS T8122 DC 30 W Midspan



AXIS T8123 High PoE 30 W Midspan 1-port



AXIS T90A Illuminators



Lenses



AXIS T8412 Installation Display



For information on AXIS Camera Station and video management software from Axis' Application Development Partners, see www.axis.com/products/video/software/

Optional accessories for outdoor models

Wall bracket accessories

Adapter plate

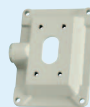

Pole mount



Corner mount

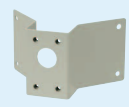

Ceiling brackets with ball joint



Column mount with ball joint

